

2023

FİYAT LİSTESİ
PRICE LIST



DEĞERLİ®

www.degerlimakina.com





Adem DEĞERLİ
Genel Müdür
General Manager

ÖNSÖZ

INTRODUCTION

SEVGİLİ DOSTLARIMIZ ;
DEĞERLİ MAKİNA bilindiği üzere 1987 yılında KONYA'da başladığı HASSAS TUTUCU TAKIM imalatına bugüne kadar yapmış olduğu teknoloji yatırımları ile beraber, kalitesinden taviz vermeden sürekli ürün çeşidini artırma yolunda ilerlemiştir. Üretimini bir kısmını yurt dışına ihraç ederek de ülke ekonomisine ciddi girdiler sağlamıştır. Firmamız siz kıymetli dostlarımıza daha iyi hizmet verebilmek amacı ile makina parkını ve personel sayısını her geçen gün artırmaya devam etmektedir. Şirketimiz ürünlerinin kalitesini ve hizmet anlayışını siz değerli dostlarımız ile paylaşmak amacı ile bir çok fuara katılarak ismine yakışır bir tanıtım yapmış ve halen de yapmaya devam etmektedir. Ayrıca ürünlerimizin ve hizmetimizin kalitesini 2006 yılında büyük bir özveri ile çalışarak almaya hak kazandığı EN ISO 9001 kalite belgesi ile kanıtlamıştır. Firmamız bundan böyle siz kıymetli dostlarımızında desteği ile daha da ileriye gidecek, aynı zamanda kalitesinden ve hizmetinden kesinlikle ödün vermeyecektir.

Dear All,

As it known, DEGERLİ MAKİNA began in 1987 in Konya PRECISION TOOL HOLDER manufacturing together with technology investments made by this time, along with continuous product range without compromising the quality of the way of improving progressed. By exporting a portion of is production abroad has contributed substantially to the national economy.

In order to better serve to our precious customers, our company always continues to increase its machinery and the number of stuff.

Our company has participated to various exhibitions and stil continues to do well for sharing our sense of our quality and services with our dear friends, In addition, the quality of our products and our services is awarded in 2006 by working with a great sacrifice has been certified by ISO 9001 quality certificate.

Our company is now going even further with your precious support of but also will not compromise on quality and service, definitely.

KALİTE / QUALITY

KALİTE POLİTİKAMIZ

Müşterilerimize dünya standartlarında, yasal ve teknik mevzuata uygun kaliteli ürünler sunmak.
Çalışanlarımızı ve tedarikçilerimizi büyüme ve gelişmemizde ortak bilip, teknolojideki yenilikleri firmamıza uyarlayarak sektörde lider firma olmak.
Personelimizin bilgi ve becerilerini artırma konusunda eğitime önem vermek.
Çevreye karşı saygılı olmak.

Sürekli iyileştirme anlayışı içinde, TEKNOLOJİ VE GÜVENİN BİRLEŞTİĞİ YER olan DEĞERLİ MAKİNA'YI her geçen gün yeni başarılarla taşımaktır.

QUALITY POLICY

*Offering high quality products in worldwide standards suitable for legal and technical regulations.
Aiming to be the leader of the sector by applying technical renovations in our company and considering our staff and suppliers as partners in growing and improvement process.
Considering on the job training important to improve skills and cognition of our staff.
Being respectful to the environment.
In view of constantly improving, taking DEĞERLİ MAKİNA, where technology and confidence combined, to sustain new success in each day.*



KALİTE / QUALITY



Ürünlerimizin kalitesinden taviz vermemek amacı ile imalat esnasında ve imalat sonrasında ürünler sürekli kontrol edilerek hataya sebebiyet vermemekteyiz. Bu kontrollerden en can alıcı olanları ise başta ISIL İŞLEM olmak üzere sonrasında yapılan SERTLİK ÖLÇME analizi, imalat esnasında yapılan YÜZEY PÜRÜZLÜLÜK hassasiyet ölçümü ve son olarak BALANS alma işlemidir. Bu işlemlerimizin tamamı raporlar halinde arşivlenerek muhafaza edilmektedir.

Ürünlerimizi müşterilerimiz tarafından daha anlaşılabilir olması için LAZER Markalama ile ürün bilgilerini ürünün üzerine yazmaktayız. Böylelikle müşterilerimiz bir daha ürün ihtiyacı olduğunda tercihini buna göre yapması kolay olacaktır. Sonuç olarak amacımız daha hassas ve daha kaliteli ürün imalatı yaparak müşterilerimizin memnuniyetini en üst seviyede tutmaktır.

In order to not to concession from the quality, the goods controlled during pre and post production process, so that we do not cause any error. The most vital important controls are foremost THERMAL PROCESS, then HARDNESS MEASUREMENT analysis, sensitivity measurement of SURFACE ROUGHNESS during production and BALANCING process. All of these procedures are being documented and kept. The product information is written on the product by LASER MARKING for the customers to be well informed about the products. Thus, our customers will be able to choose the product easily next time. Consequently, our purpose is to manufacture more sensitive and quality goods and keep customer satisfaction at the highest level.





INDEX

**DIN 69893 FORM A
HSK TUTUCULAR**
HSK TOOLHOLDERS

A-01
A-29



**DIN 69871 AD
SK TUTUCULAR**
SK TOOLHOLDERS

B-01
B-29



**JIS B 6339 (MAS 403 BT)
BT TUTUCULAR**
BT TOOLHOLDERS

C-01
C-30



**JIS B 6339 (MAS 403 BBT)
BBT TUTUCULAR**
BBT TOOLHOLDERS

D-01
D-17



**DIN 2080
ISO TUTUCULAR**
ISO TOOLHOLDERS

E-01
E-14



**SİLİNDİRİK ŞAFTLI
TUTUCULAR**
*CYLINDRICAL SHAFT
TOOLHOLDERS*

F-01
F-14



**PENSLER VE
DİĞER ÜRÜNLER**
*COLLETS AND
OTHER PRODUCTS*

G-01
G-44

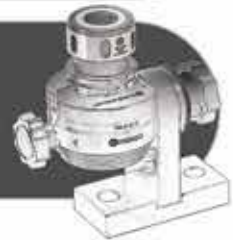

HSK TOOLHOLDERS



HSK TUBULAR
HSK TOOLHOLDERS

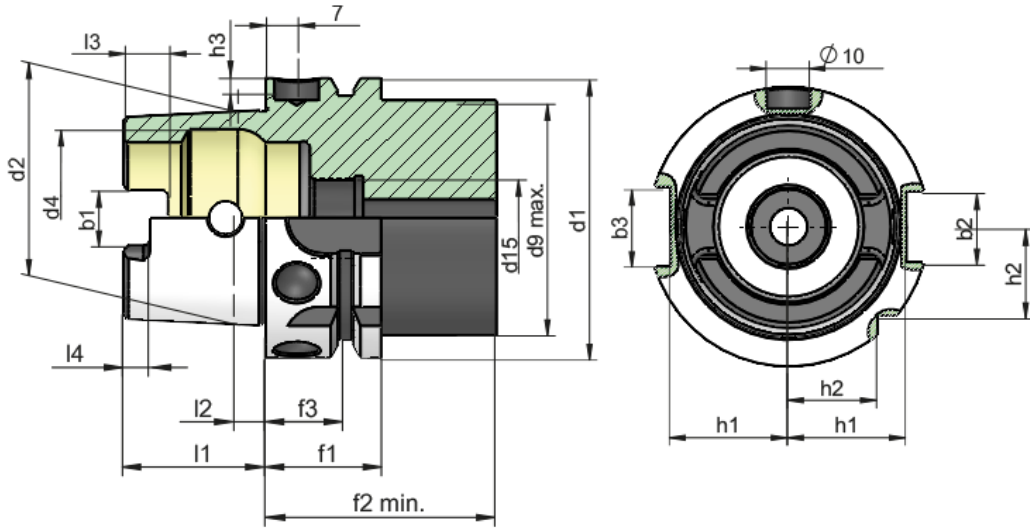

STANDART
BALANS
G 2,5
25000 min⁻¹



58-60 HRC



CHIP

HSK - A d1	d2	d4	d9	d15	b1	b2	b3	f1	f2	f3	h1	h2	h3	l1	l2	l3	l4
63	48,010	40	53	M18x1	12,54	16	18	26	42	18	26,5	20	5	32	6,3	10	6

ISO 12164 (DIN 69893 FORM A)

DIN 6499 ER SERİSİ PENS BAŞLIĞI

DIN 6499 ER SERIES COLLET CHUCK

DEĞERLİ®
www.degerlimakina.com

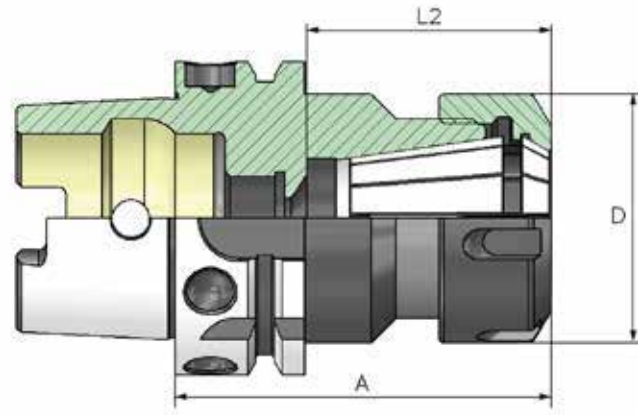
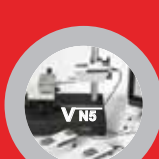

Sipariş Kodu Order Number	HSK	Kapasite Capacity (d)	D	A	L2	€
811426	HSK A63	ER 16 (2-10)	28	75	32	71
811430	HSK A63	ER 25 (2-16)	42	75	42	74
811470	HSK A63	ER 32 (2-20)	50	75	48	79
811472	HSK A63	ER 40 (2-26)	63	85	55	83



DEĞERLİ
www.degerlimakina.com

ISO 12164 (DIN 69893 FORM A)

DIN 6499 ER SERİSİ PENS BAŞLIĞI

DIN 6499 ER SERIES COLLET CHUCK

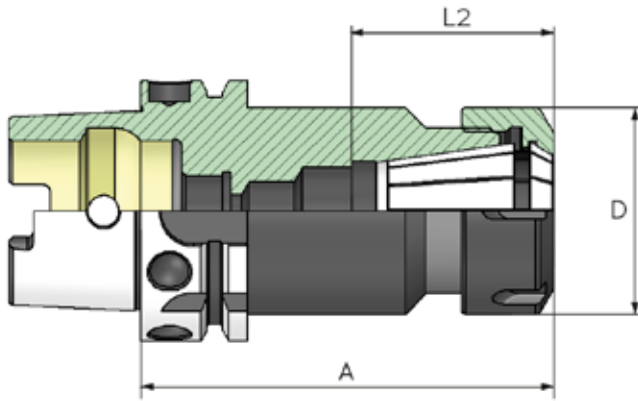

Sipariş Kodu Order Number	HSK	Kapasite Capacity (d)	D	A	L2	€
812426	HSK A63	ER 16 (2-10)	28	100	32	80
812426-1	HSK A63	ER 16 Mini (2-10)	22	100	32	111
812428	HSK A63	ER 20 (2-13)	35	100	39,5	86
812430	HSK A63	ER 25 (2-16)	42	100	42	83
812470	HSK A63	ER 32 (2-20)	50	100	48	86
812472	HSK A63	ER 40 (2-26)	63	120	55	93

ISO 12164 (DIN 69893 FORM A)

DIN 6499 ER SERİSİ PENS BAŞLIĞI

DIN 6499 ER SERIES COLLET CHUCK

DEĞERLİ

www.degerlimakina.com

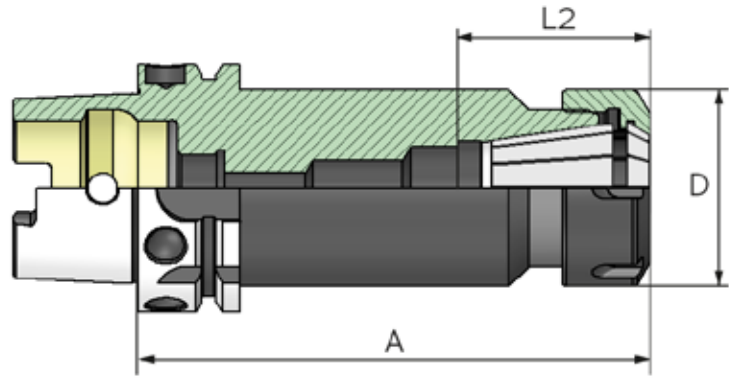

Sipariş Kodu Order Number	HSK	Kapasite Capacity (d)	D	A	L2	€
813426	HSK A63	ER 16 (2-10)	28	130	32	94
813426-1	HSK A63	ER 16 MİNİ (2-10)	22	130	32	129
813428	HSK A63	ER 20 (2-13)	35	130	39,5	101
813430	HSK A63	ER 25 (2-16)	42	130	42	98
813470	HSK A63	ER 32 (2-20)	50	130	48	101
813472	HSK A63	ER 40 (2-26)	63	130	55	105

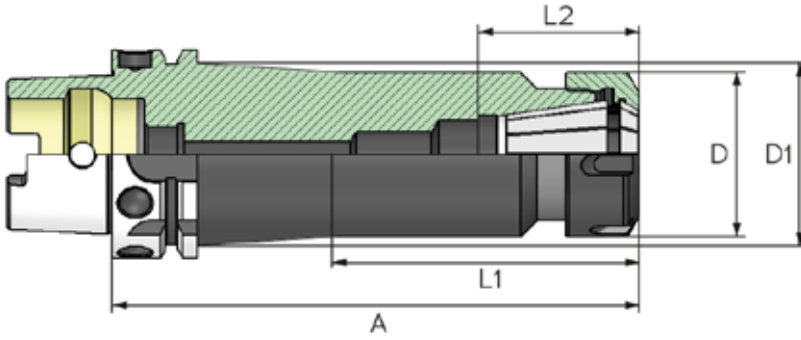

Sipariş Kodu Order Number	HSK	Kapasite Capacity (d)	D	A	D1	L1	L2	€
814426	HSK A63	ER 16 (2-10)	28	160	31,5	98	32	109
814426-1	HSK A63	ER 16 Mini (2-10)	22	160	25,5	98	32	145
814428	HSK A63	ER 20 (2-13)	35	160	37,5	99,5	39,5	115
814430	HSK A63	ER 25 (2-16)	42	160	45,5	100	42	111
814470	HSK A63	ER 32 (2-20)	50	160	-	-	48	115
814472	HSK A63	ER 40 (2-26)	63	160	-	-	55	119

ISO 12164 (DIN 69893 FORM A)

RULMANLI PENS BAŞLIĞI
PRECISION MILLING CHUCK

DEĞERLİ®
www.degerlimakina.com

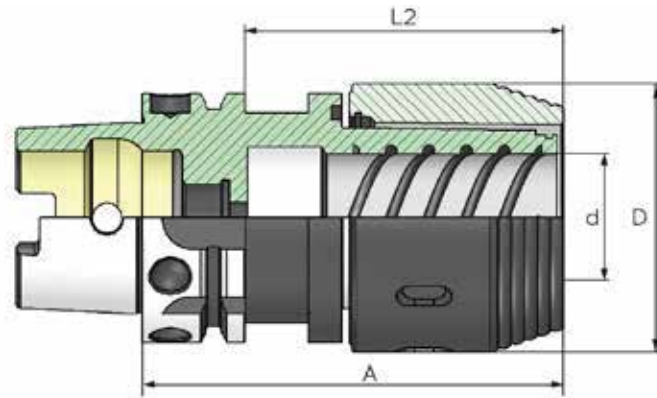

Sipariş Kodu Order Number	HSK	Kapasite Capacity (d)	d	D	A	L2	€
818420	HSK A63	RPT 20 (6-20)	20	48	95	70	331
818420-1	HSK A63	RPT 20 (6-20)	20	48	130	80	425
818420-2	HSK A63	RPT 20 (6-20)	20	48	160	80	494
818420-3	HSK A63	RPT 20 (6-20)	20	48	200	80	535
818432	HSK A63	RPT 32 (6-32)	32	68	105	70	363
818432-1	HSK A63	RPT 32 (6-32)	32	68	130	80	431
818432-2	HSK A63	RPT 32 (6-32)	32	68	160	80	500
818432-3	HSK A63	RPT 32 (6-32)	32	68	200	80	561



DEĞERLİ®
www.degerlimakina.com

ISO 12164 (DIN 69893 FORM A)

DIN 69882-2 KOMBİNE TARAMA TUTUCUSU

DIN 69882-2 COMBI SHELL MILL HOLDER

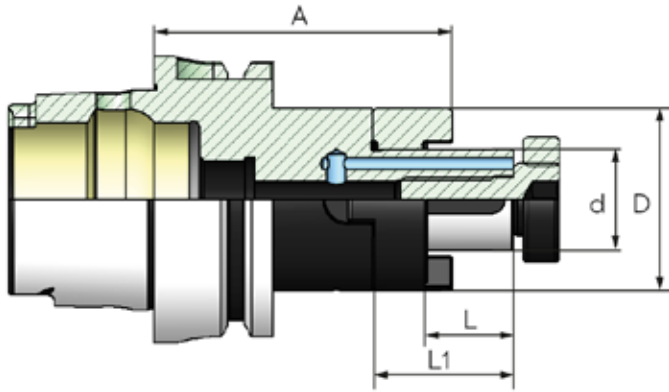

Sipariş Kodu Order Number	HSK	d	D	A	L	L1	€
824016	HSK A63	16	32	60	17	27	98
824022	HSK A63	22	40	60	19	31	98
824027	HSK A63	27	48	60	21	33	98
824032	HSK A63	32	58	60	24	38	104
824040	HSK A63	40	70	70	27	41	120

ISO 12164 (DIN 69893 FORM A)

DIN 69882-2 KOMBİNE TARAMA TUTUCUSU

DIN 69882-2 COMBI SHELL MILL HOLDER

DEĞERLİ®
www.degerlimakina.com

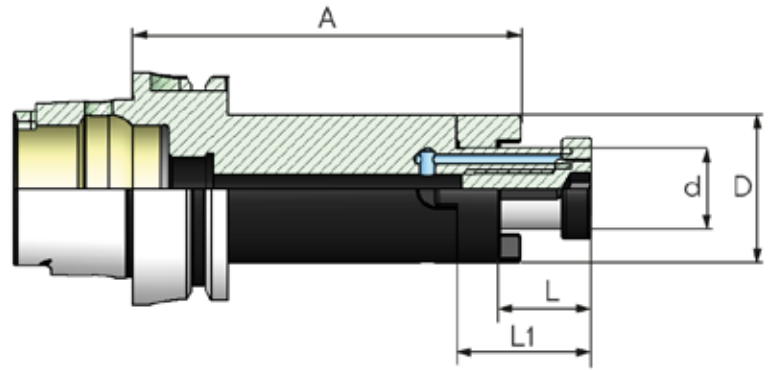

Sipariş Kodu Order Number	HSK	d	D	A	L	L1	€
824016-1	HSK A63	16	32	100	17	27	111
824022-1	HSK A63	22	40	100	19	31	111
824027-1	HSK A63	27	48	100	21	33	111
824032-1	HSK A63	32	58	100	24	38	133
824040-1	HSK A63	40	70	100	27	41	130

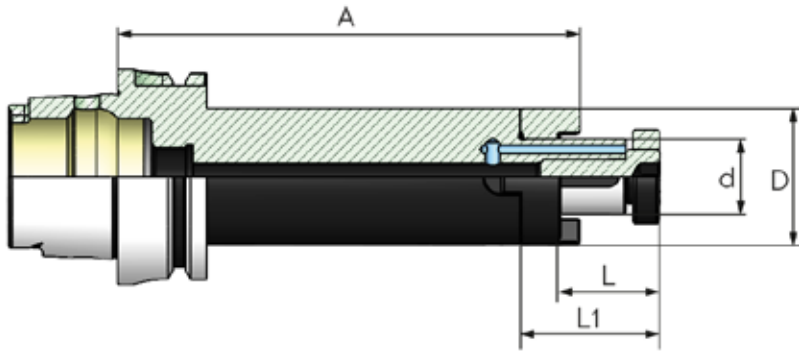

Sipariş Kodu Order Number	HSK	d	D	A	L	L1	€
824016-2	HSK A63	16	32	130	17	27	123
824022-2	HSK A63	22	40	130	19	31	123
824027-2	HSK A63	27	48	130	21	33	123
824032-2	HSK A63	32	58	130	24	38	141
824040-2	HSK A63	40	70	130	27	41	141

ISO 12164 (DIN 69893 FORM A)

DIN 69882-2 KOMBİNE TARAMA TUTUCUSU

DIN 69882-2 COMBI SHELL MILL HOLDER

DEĞERLİ®
www.degerlimakina.com

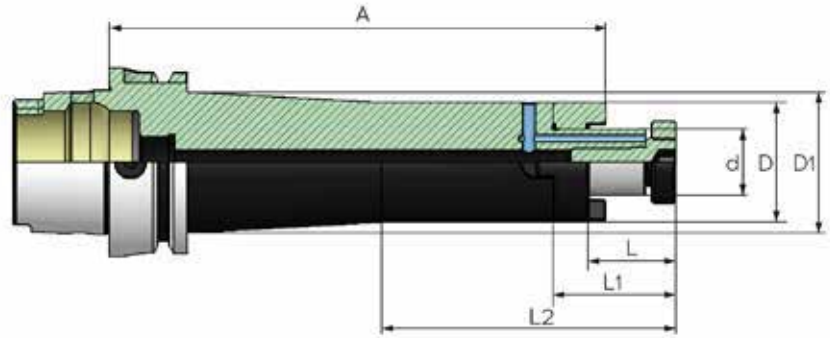

Sipariş Kodu Order Number	HSK	d	D	D1	A	L	L1	L2	€
824016-3	HSK A63	16	32	38,5	160	17	27	88	133
824022-3	HSK A63	22	40	47	160	19	31	88	133
824027-3	HSK A63	27	48	-	160	21	33	-	133
824032-3	HSK A63	32	58	-	160	24	38	-	154
824040-3	HSK A63	40	70	-	160	27	41	-	154



DEĞERLİ
www.degerlimakina.com

ISO 12164 (DIN 69893 FORM A)

DIN 69882-2 KOMBİNE TARAMA TUTUCUSU

DIN 69882-2 COMBI SHELL MILL HOLDER

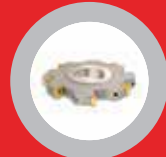
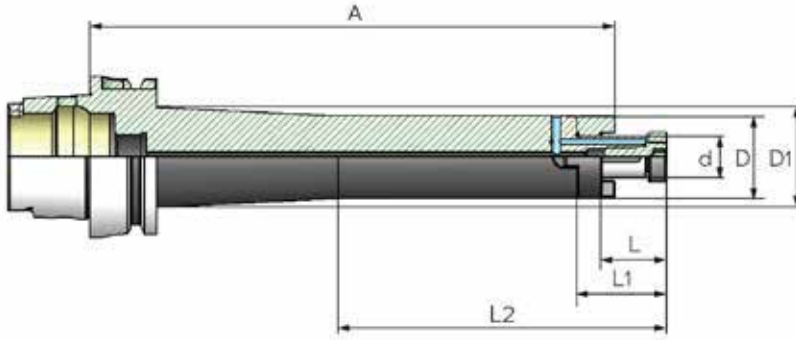

Sipariş Kodu Order Number	HSK	d	D	D1	A	L	L1	L2	€
824016-4	HSK A63	16	32	39	200	17	27	120	159
824022-4	HSK A63	22	40	48	200	19	31	120	159
824027-4	HSK A63	27	48	-	200	21	33	-	159

ISO 12164 (DIN 69893 FORM A)

DIN 6357 ALIN KAMALI TARAMA TUTUCUSU

DIN 6357 SHELL MILL HOLDER

DEĞERLİ®
www.degerlimakina.com

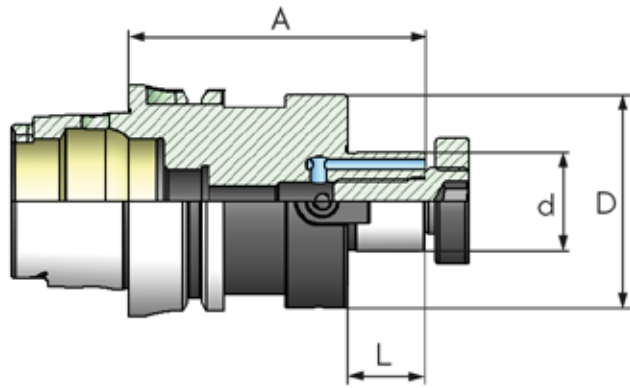

Sipariş Kodu Order Number	HSK	d	D	A	L	€
834016	HSK A63	16	38	50	17	98
834022	HSK A63	22	48	50	19	98
834027	HSK A63	27	60	60	21	98
834032	HSK A63	32	78	60	24	104
834040	HSK A63	40	88	60	27	113

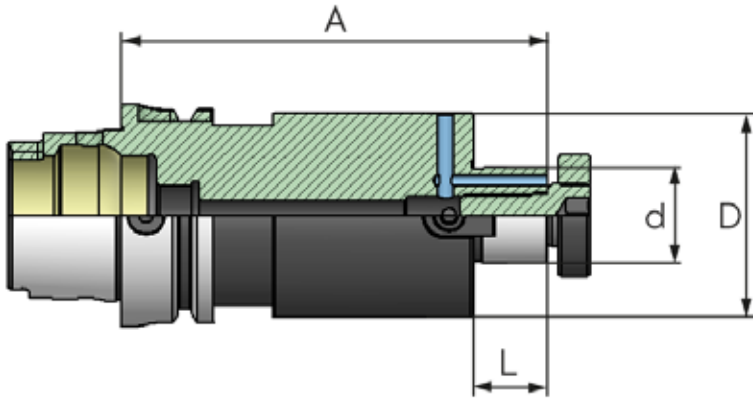

Sipariş Kodu Order Number	HSK	d	D	A	L	€
834016-1	HSK A63	16	38	100	17	113
834022-1	HSK A63	22	48	100	19	113
834027-1	HSK A63	27	60	100	21	113
834032-1	HSK A63	32	78	100	24	119
834040-1	HSK A63	40	88	100	27	123

ISO 12164 (DIN 69893 FORM A)

DIN 6357 ALIN KAMALI TARAMA TUTUCUSU

DIN 6357 SHELL MILL HOLDER

DEĞERLİ®
www.degerlimakina.com

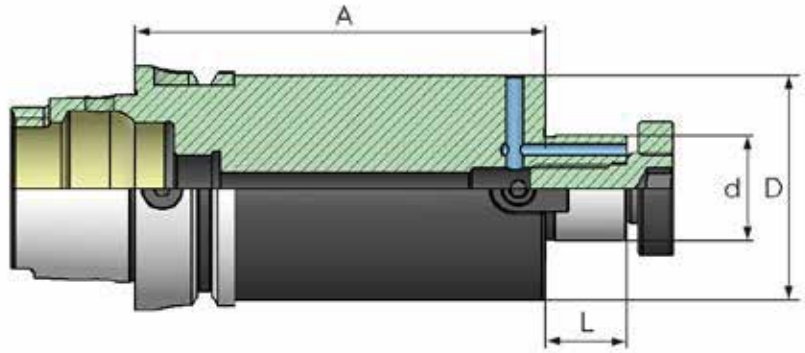

Sipariş Kodu Order Number	HSK	d	D	A	L	€
834016-2	HSK A63	16	38	130	17	118
834022-2	HSK A63	22	48	130	19	118
834027-2	HSK A63	27	60	130	21	118
834032-2	HSK A63	32	78	130	24	125
834040-2	HSK A63	40	88	130	27	131



DEĞERLİ
www.degerlimakina.com

ISO 12164 (DIN 69893 FORM A)

DIN 6357 ALIN KAMALI TARAMA TUTUCUSU

DIN 6357 SHELL MILL HOLDER

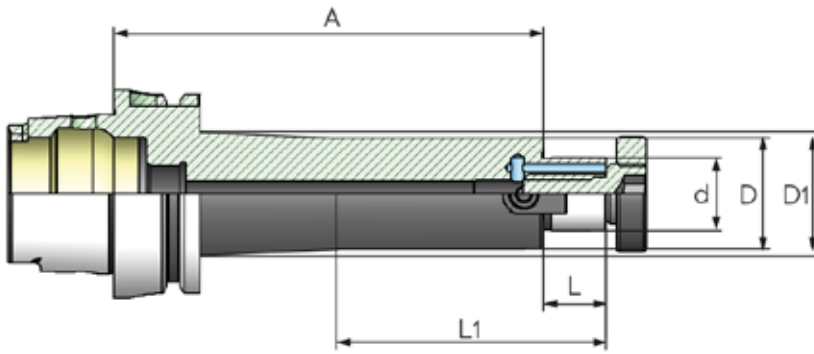

Sipariş Kodu Order Number	HSK	d	D	A	L	€
834016-3	HSK A63	16	38	160	17	123
834022-3	HSK A63	22	48	160	19	123
834027-3	HSK A63	27	60	160	21	128
834032-3	HSK A63	32	78	160	24	133
834040-3	HSK A63	40	88	160	27	144

ISO 12164 (DIN 69893 FORM A)

DIN 6359 VELDON TUTUCU - DIN 1835-B

DIN 6359 END MILL HOLDER - DIN 1835-B

DEĞERLİ®

www.degerlimakina.com

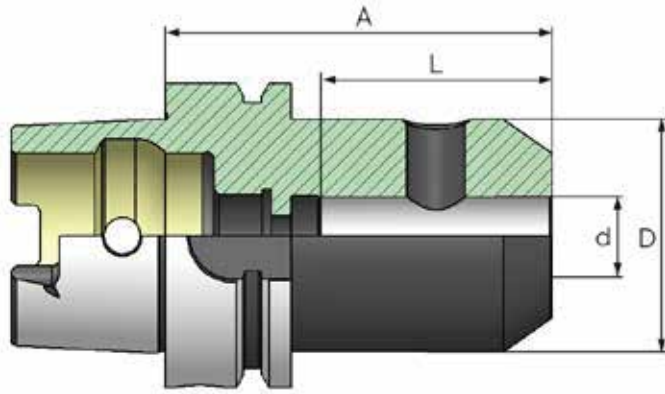

Sipariş Kodu Order Number	HSK	d	D	A	L	€
844006	HSK A63	6	25	65	36	84
844008	HSK A63	8	28	65	40	80
844010	HSK A63	10	35	65	41	80
844012	HSK A63	12	42	80	51	80
844014	HSK A63	14	44	80	51	80
844016	HSK A63	16	48	80	54	80
844018	HSK A63	18	50	80	54	80
844020	HSK A63	20	52	80	56	80
844025	HSK A63	25	63	110	64	89
844032	HSK A63	32	72	110	68	96
844040	HSK A63	40	80	125	78	108

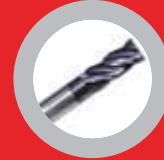
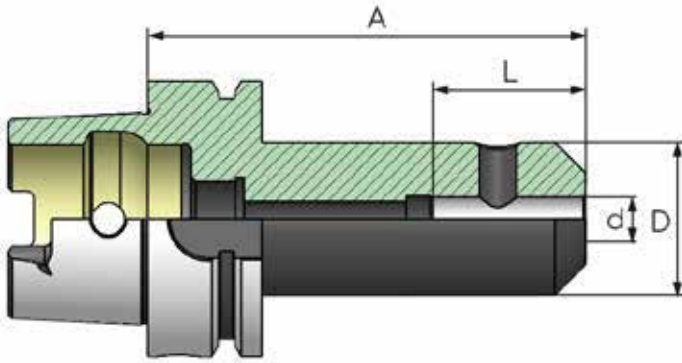

Sipariş Kodu Order Number	HSK	d	D	A	L	€
844006-1	HSK A63	6	25	100	36	101
844008-1	HSK A63	8	28	100	40	101
844010-1	HSK A63	10	35	100	44	101

ISO 12164 (DIN 69893 FORM A)

DIN 6359 VELDON TUTUCU - DIN 1835-B

DIN 6359 END MILL HOLDER - DIN 1835-B

DEĞERLİ®

www.degerlimakina.com



SAYFA/PAGE: G-35



SAYFA/PAGE: G-35



SAYFA/PAGE: G-27



58-60 HRC



VN6

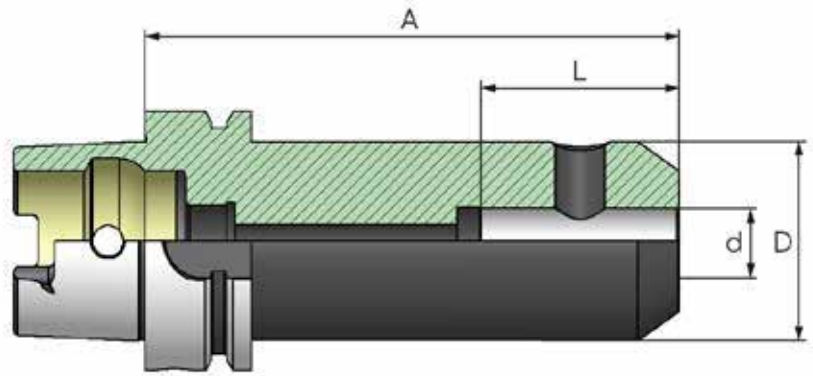

Sipariş Kodu Order Number	HSK	d	D	A	L	€
844006-2	HSK A63	6	25	130	36	116
844008-2	HSK A63	8	28	130	40	116
844010-2	HSK A63	10	35	130	44	116
844012-2	HSK A63	12	42	130	51	116
844014-2	HSK A63	14	44	130	51	116
844016-2	HSK A63	16	48	130	54	116
844018-2	HSK A63	18	50	130	54	116
844020-2	HSK A63	20	52	130	56	116



DEĞERLİ
www.degerlimakina.com

ISO 12164 (DIN 69893 FORM A)

DIN 6359 VELDON TUTUCU - DIN 1835-B

DIN 6359 END MILL HOLDER - DIN 1835-B

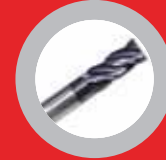
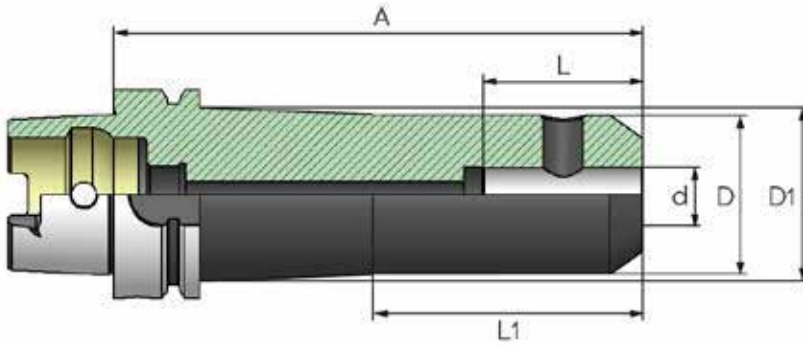

Sipariş Kodu Order Number	HSK	d	D	D1	A	L	€
844006-3	HSK A63	6	25	29,5	160	36	133
844008-3	HSK A63	8	28	32,5	160	40	133
844010-3	HSK A63	10	35	39,5	160	44	133
844012-3	HSK A63	12	42	47	160	51	133
844014-3	HSK A63	14	44	49	160	51	133
844016-3	HSK A63	16	48	-	160	54	133
844018-3	HSK A63	18	50	-	160	54	133
844020-3	HSK A63	20	52	-	160	56	133

ISO 12164 (DIN 69893 FORM A)

DIN 6359 VELDON TUTUCU İÇTEN SOĞUTMA KANALLI

DIN 6359 END MILL HOLDER WITH COOLANT CHANNEL

DEĞERLİ
www.degerlimakina.com

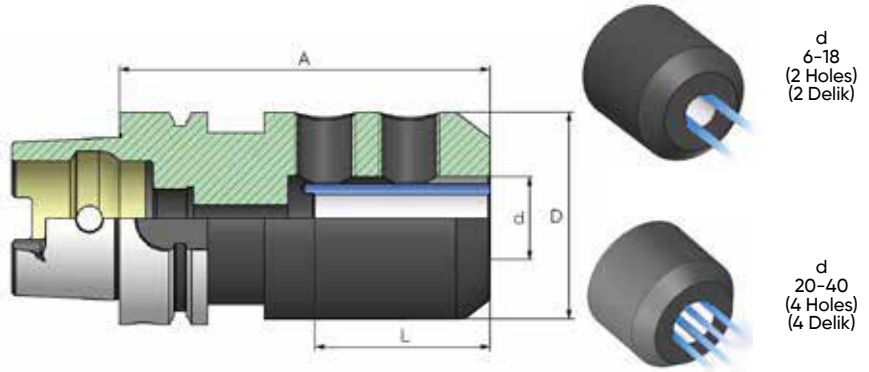

Sipariş Kodu Order Number	HSK	d	D	A	L	€
844106	HSK A63	6	25	65	36	101
844108	HSK A63	8	28	65	40	99
844110	HSK A63	10	35	65	41	99
844112	HSK A63	12	42	80	51	99
844114	HSK A63	14	44	80	51	99
844116	HSK A63	16	48	80	54	99
844118	HSK A63	18	50	80	54	99
844120	HSK A63	20	52	80	56	99
844125	HSK A63	25	63	110	64	103
844132	HSK A63	32	72	110	68	111
844140	HSK A63	40	80	125	78	133



DEĞERLİ
www.degerlimakina.com

ISO 12164 (DIN 69893 FORM A)

DIN 6383 KAMALI MORS ADAPTÖRÜ

DIN 6383 MORSE TAPER ADAPTOR

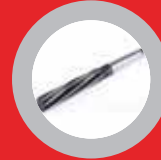
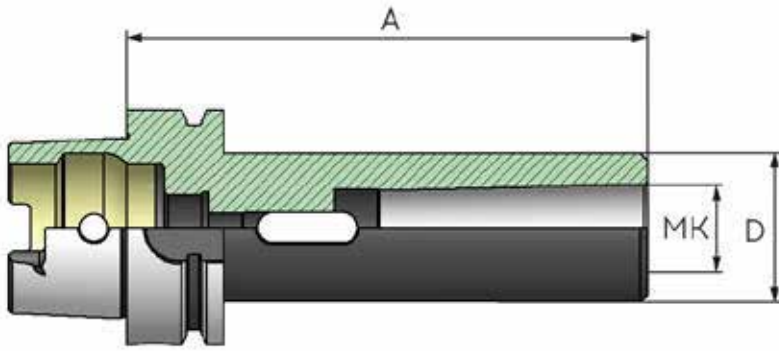

Sipariş Kodu Order Number	HSK	MK	A	D	€
854001	HSK A63	MK 1	100	25	90
854002	HSK A63	MK 2	120	32	90
854003	HSK A63	MK 3	140	40	93
854004	HSK A63	MK 4	160	48	94

ISO 12164 (DIN 69893 FORM A)

KLAVUZ ÇEKME BAŞLIĞI GİRİŞ VE ÇIKIŞ KOMPANZİYELİ

QUICK-CHANGE TAPPING CHUCKS WITH LENGTH COMPENSATION

DEĞERLİ®
www.degerlimakina.com



SAYFA/PAGE: G-35



SAYFA/PAGE: G-23/24/25



SAYFA/PAGE: G-27



58-60 HRC

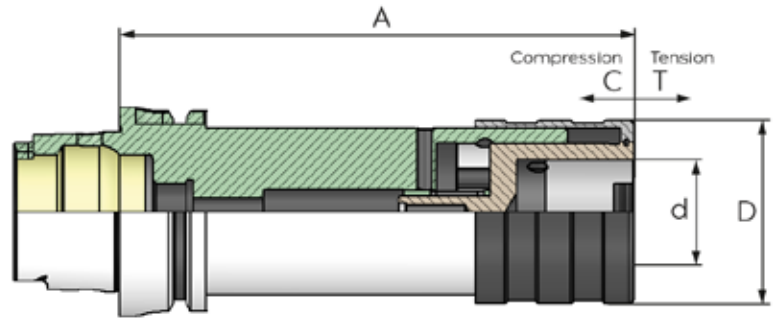

Sipariş Kodu Order Number	HSK	Kapasite Capacity	d	A	D	C	T	€
877214	HSK A63	M2-M14	19	104	36,5	7	7	323
877524	HSK A63	M5-M24	31	152	53,5	12	12	359



DEĞERLİ®
www.degerlimakina.com

ISO 12164 (DIN 69893 FORM A)

VİDALI FREZE TAKIM TUTUCULARI

SET HOLDERS FOR SCREW MILLING CUTTERS

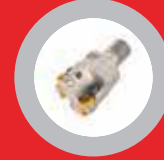
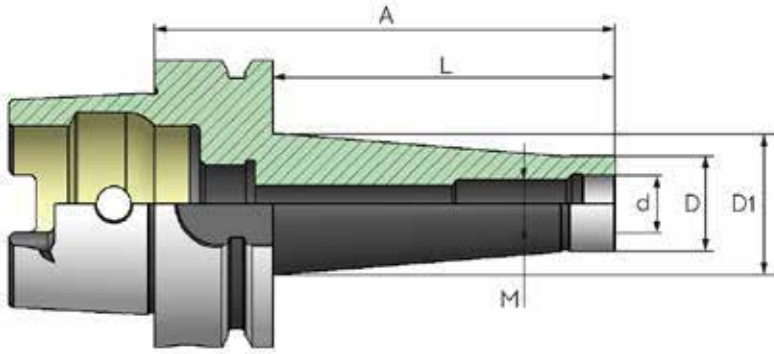

Sipariş Kodu Order Number	HSK	M	A	L	d	D	D1	€
884006	HSK A63	M6	51	25	6,5	10	13	136
884008	HSK A63	M8	51	25	8,5	13	15	136
884008-1	HSK A63	M8	76	50	8,5	13	22,5	143
884008-2	HSK A63	M8	101	75	8,5	13	23	154
884010	HSK A63	M10	51	25	10,5	18	20	136
884010-1	HSK A63	M10	76	50	10,5	18	23	143
884010-2	HSK A63	M10	101	75	10,5	18	23	166
884010-3	HSK A63	M10	126	100	10,5	18	32	169
884010-4	HSK A63	M10	151	125	10,5	18	34	188
884010-5	HSK A63	M10	176	150	10,5	18	36	190

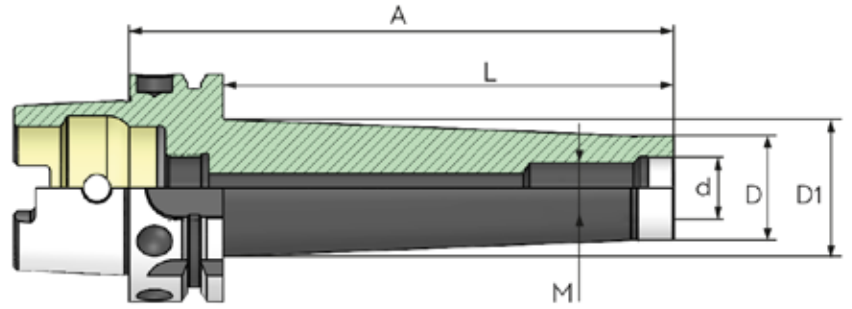
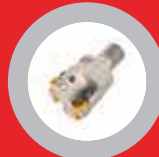

Sipariş Kodu Order Number	HSK	M	A	L	d	D	D1	€
884012	HSK A63	M12	51	25	12,5	21	24	136
884012-1	HSK A63	M12	76	50	12,5	21	24	143
884012-2	HSK A63	M12	101	75	12,5	21	31	154
884012-3	HSK A63	M12	126	100	12,5	21	33	169
884012-4	HSK A63	M12	151	125	12,5	21	35	188
884012-5	HSK A63	M12	176	150	12,5	21	39,5	190
884016	HSK A63	M16	51	25	17	29	-	136
884016-1	HSK A63	M16	76	50	17	29	34	143
884016-2	HSK A63	M16	101	75	17	29	34	154
884016-3	HSK A63	M16	126	100	17	29	36	169
884016-4	HSK A63	M16	151	125	17	29	38	188
884016-5	HSK A63	M16	176	150	17	29	42,5	190



DEĞERLİ
www.degerlimakina.com

ISO 12164 (DIN 69893 FORM A)

VİDALI FREZE TAKIM TUTUCULARI, İNCE CİDARLI

SET HOLDERS FOR SCREW MILLING CUTTERS, SLIMLINE DESIGN

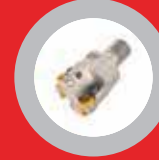
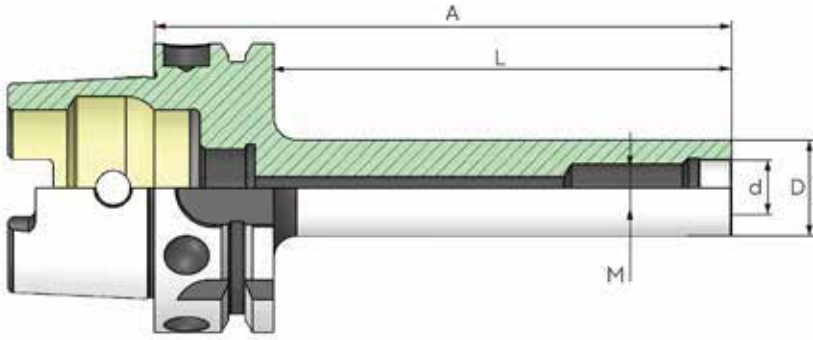
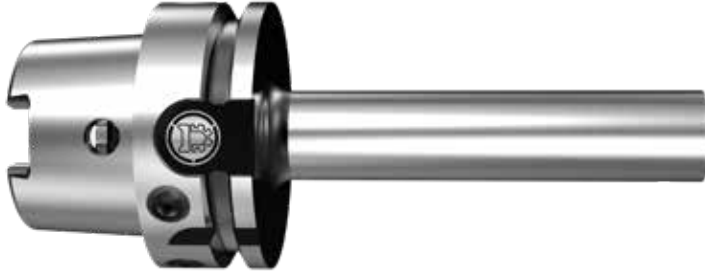

Sipariş Kodu Order Number	HSK	M	A	d	D	L	€
884110-3	HSK A63	M10	126	10,5	18	100	199
884110-5	HSK A63	M10	176	10,5	18	150	223
884112-2	HSK A63	M12	101	12,5	21	75	180
884112-3	HSK A63	M12	126	12,5	21	100	199
884112-5	HSK A63	M12	176	12,5	21	150	223
884116-2	HSK A63	M16	101	17	29	75	180
884116-3	HSK A63	M16	126	17	29	100	199
884116-5	HSK A63	M16	176	17	29	150	223

ISO 12164 (DIN 69893 FORM A)

ÖZEL TAKIM YAPMAK İÇİN YUMUŞAK BARA

BORING BAR BLANKS FOR PRODUCTION OF SPECIAL TOOLS

DEĞERLİ®

www.degerlimakina.com

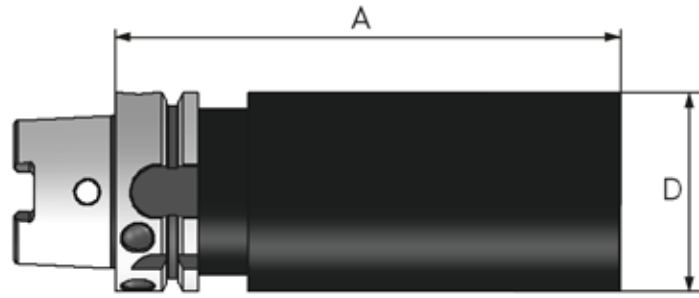

Sipariş Kodu Order Number	HSK	D	A	€
894000	HSK A63	63	160	164
894000-1	HSK A63	63	310	199
894000-2	HSK A63	80	250	199
894000-3	HSK A63	120	160	205



DEĞERLİ®
www.degerlimakina.com

ISO 12164 (DIN 69893 FORM A)

ER SERİSİ PENS TAKIMI

ER SERIES COLLET SET IN BOX



SAYFA/PAGE: G-35



SAYFA/PAGE: G-29



SAYFA/PAGE: G-27



SAYFA/PAGE: G-19



SAYFA/PAGE: G-02/03/04/05/06



SAYFA/PAGE: G-43



SAYFA/PAGE: A-03

Sipariş Kodu Order Number	HSK	Adet Piece	Ölçüler Contents	€
894430	HSK A63 - ER 25	14	3-4-5-6-7-8-9-10-11-12-14-16-9042430-811430	305
894470	HSK A63 - ER 32	16	3-4-5-6-7-8-9-10-11-12-14-16-18-20-905470-811470	398
894472	HSK A63 - ER 40	18	4-5-6-7-8-9-10-11-12-14-16-18-20-22-24-26-9063472-811472	470

ISO 12164 (DIN 69893 FORM A)

RULMANLI PENS TAKIMI

PRECISION MILLING CHUCK SET IN BOX

DEĞERLİ®

www.degerlimakina.com



Sipariş Kodu Order Number	HSK	Adet Piece	Ölçüler Contents	€
898420	HSK A63 - Ø 20	7	6-8-10-12-16-904550-818420	513
898432	HSK A63 - Ø 32	9	6-8-10-12-16-20-25-906875-818432	638

DIN 69871 AD
SK TUTUCULAR
SK TOOLHOLDERS



SKTOOLHOLDERS

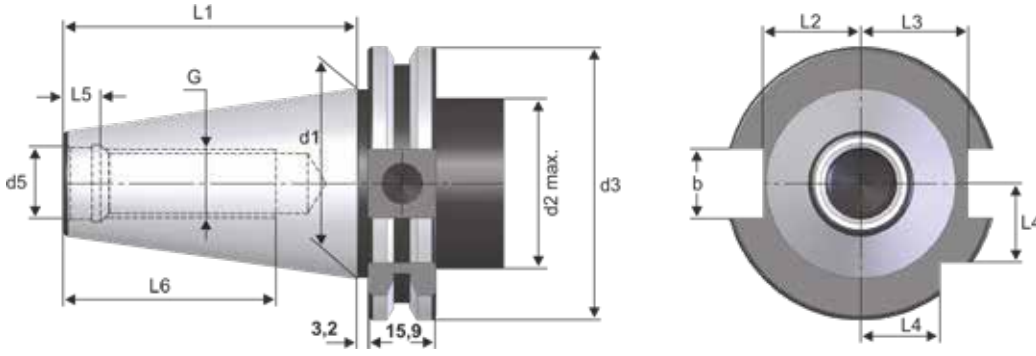

STANDART
BALANS
G 6,3
15000 min⁻¹



58-60 HRC



Ürün Adı Product Name	d1	G	d5	d2	d3	L1	L2	L3	L4	L5	L6	b
SK 30	31,75	M12	13	45	50,00	47,80	16,4	19,0	15	5,5	24	16,1
SK 40	44,45	M16	17	50	63,55	68,40	22,8	25,0	18,5	8,2	32	16,1
SK 50	69,85	M24	25	80	97,50	101,75	35,5	37,7	30	11,5	47	25,7

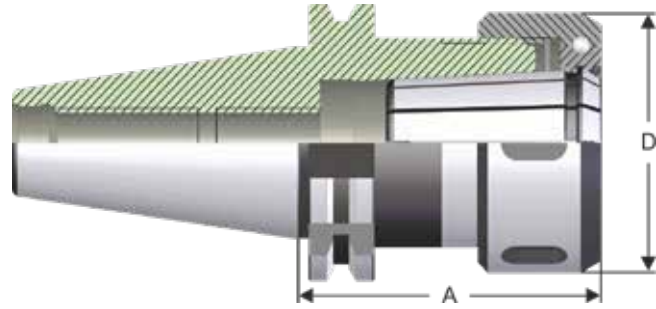

Sipariş Kodu Order Number	SK	Kapasite Capacity (d)	D	A	€
510415	SK 30	415 (2-16)	43	60	69
510462	SK 30	462 (2-25)	60	80	70
511415	SK 40	415 (2-16)	43	70	64
511462	SK 40	462 (2-25)	60	70	66
511467	SK 40	467 (3-32)	72	90	77
515462	SK 50	462 (2-25)	60	70	88
515467	SK 50	467 (3-32)	72	80	91
515468	SK 50	468 (3-40)	85	95	147

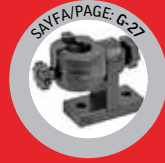
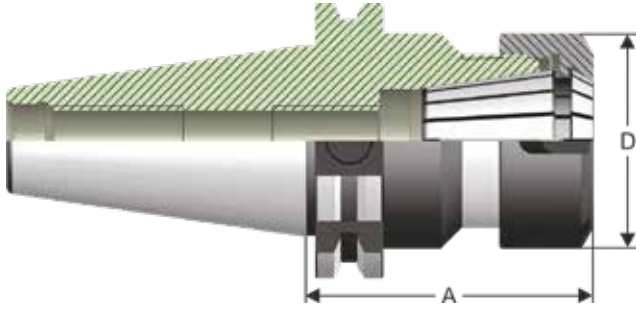

Sipariş Kodu Order Number	SK	Kapasite Capacity (d)	D	A	€
510426	SK 30	ER 16 (2-10)	32	70	51
510430	SK 30	ER 25 (2-16)	42	70	53
510470	SK 30	ER 32 (2-20)	50	70	54
510472	SK 30	ER 40 (2-26)	63	70	58
511426	SK 40	ER 16 (2-10)	32	63	49
511430	SK 40	ER 25 (2-16)	42	60	50
511470	SK 40	ER 32 (2-20)	50	70	52
511472	SK 40	ER 40 (2-26)	63	80	55
515426	SK 50	ER 16 (2-10)	32	63	66
515430	SK 50	ER 25 (2-16)	42	60	69
515470	SK 50	ER 32 (2-20)	50	70	71
515472	SK 50	ER 40 (2-26)	63	80	74

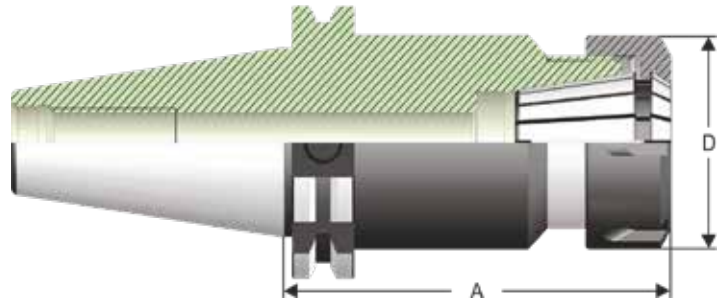

Sipariş Kodu Order Number	SK	Kapasite Capacity (d)	D	A	€
510426-1	SK 30	ER 16 (2-10)	32	100	61
510430-1	SK 30	ER 25 (2-16)	42	100	63
510470-1	SK 30	ER 32 (2-20)	50	100	65
512426-1	SK 40	ER 16 (2-10) Mini	22	100	74
512426	SK 40	ER 16 (2-10)	32	100	57
512430	SK 40	ER 25 (2-16)	42	100	59
512470	SK 40	ER 32 (2-20)	50	100	62
512472	SK 40	ER 40 (2-26)	63	100	66
516426	SK 50	ER 16 (2-10)	32	100	81
516426-1	SK 50	ER 16 (2-10) Mini	22	100	102
516430	SK 50	ER 25 (2-16)	42	100	83
516470	SK 50	ER 32 (2-20)	50	100	84
516472	SK 50	ER 40 (2-26)	63	100	89

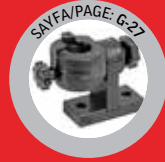
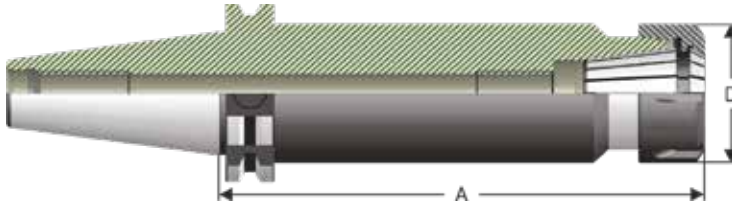

Sipariş Kodu Order Number	SK	Kapasite Capacity (d)	D	A	€
513426-1	SK 40	ER 16 MİNİ (2-10)	22	160	104
513426	SK 40	ER 16 (2-10)	32	160	73
513430	SK 40	ER 25 (2-16)	42	160	73
513470	SK 40	ER 32 (2-20)	50	160	81
513472	SK 40	ER 40 (2-26)	63	160	85

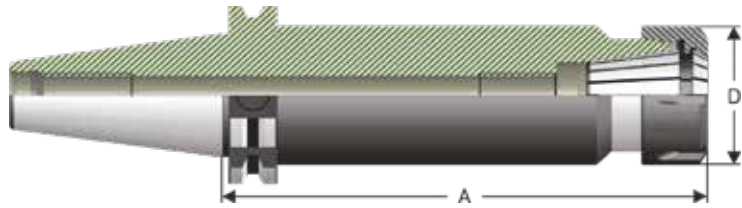
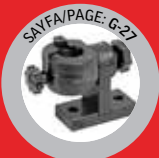

Sipariş Kodu Order Number	SK	Kapasite Capacity (d)	D	A	€
517426-1	SK 50	ER 16 Mini (2-10)	22	160	168
517426	SK 50	ER 16 (2-10)	32	160	105
517430	SK 50	ER 25 (2-16)	42	160	105
517470	SK 50	ER 32 (2-20)	50	160	105
517472	SK 50	ER 40 (2-26)	63	160	114

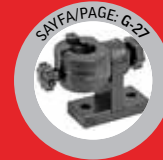
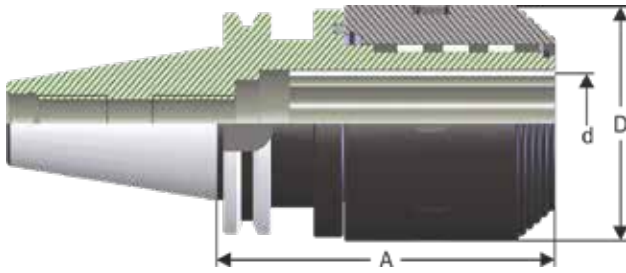

Sipariş Kodu Order Number	SK	Kapasite Capacity (d)	A	D	€
518420	SK 40	6-20 mm	90	49	277
518432	SK 40	6-32 mm	100	68	308
519520	SK 50	6-20 mm	70	49	413
519532	SK 50	6-32 mm	95	68	420

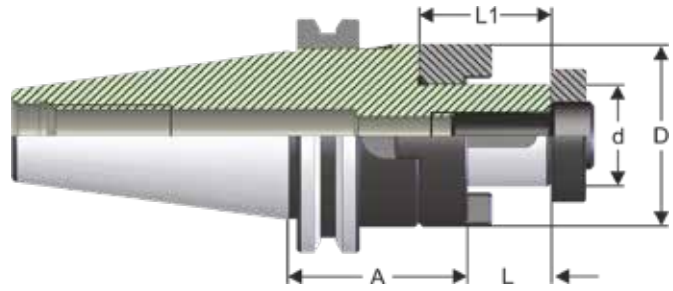

Sipariş Kodu Order Number	SK	d h6	D	A	L	L1	€
523016	SK 30	16	32	50	17	27	50
523022	SK 30	22	40	50	19	31	50
523027	SK 30	27	48	55	21	33	50
523032	SK 30	32	58	60	24	38	54
524016	SK 40	16	32	55	17	27	48
524022	SK 40	22	40	55	19	31	48
524027	SK 40	27	48	55	21	33	48
524032	SK 40	32	58	60	24	38	52
524040	SK 40	40	70	60	27	41	57
525016	SK 50	16	32	55	17	27	63
525022	SK 50	22	40	55	19	31	63
525027	SK 50	27	48	55	21	33	65
525032	SK 50	32	58	55	24	38	71
525040	SK 50	40	70	55	27	41	78

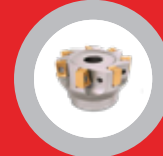
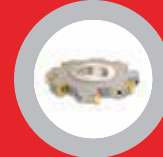
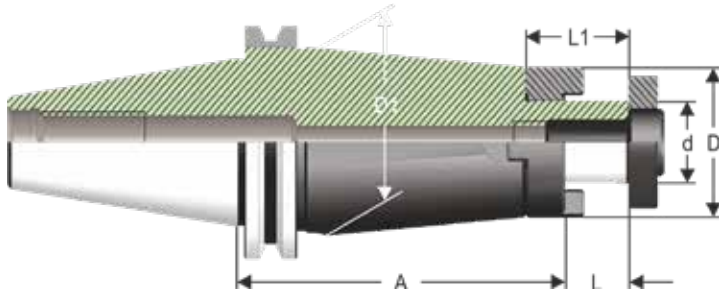

Sipariş Kodu Order Number	SK	d h6	D	A	L	L1	D1	€
524116	SK 40	16	32	100	17	27	38	59
524122	SK 40	22	40	100	19	31	48	59
524127	SK 40	27	48	100	21	33	50	59
524132	SK 40	32	58	100	24	38	58	64
524140	SK 40	40	70	100	27	41	70	73
525116	SK 50	16	32	100	17	27	38	87
525122	SK 50	22	40	100	19	31	48	87
525127	SK 50	27	48	100	21	33	58	89
525132	SK 50	32	58	100	24	38	68	93
525140	SK 50	40	70	100	27	41	80	98

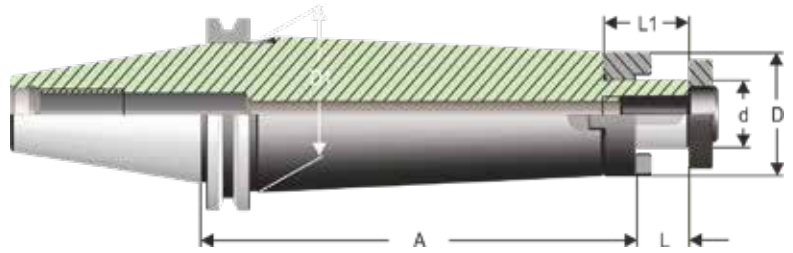

Sipariş Kodu Order Number	SK	d h6	D	A	L	L1	D1	€
524116.1	SK 40	16	32	160	17	27	38	98
524122.1	SK 40	22	40	160	19	31	48	98
524127.1	SK 40	27	48	160	21	33	50	98
524132.1	SK 40	32	58	160	24	38	58	102
524140.1	SK 40	40	70	160	27	41	70	122
525116.1	SK 50	16	32	160	17	27	38	131
525122.1	SK 50	22	40	160	19	31	48	131
525127.1	SK 50	27	48	160	21	33	58	131
525132.1	SK 50	32	58	160	24	38	68	138
525140.1	SK 50	40	70	160	27	41	80	150

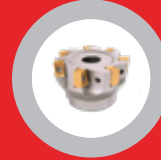
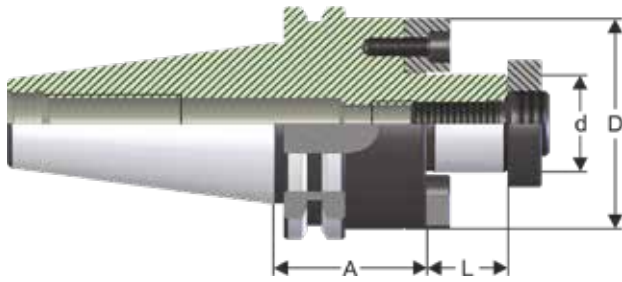

Sipariş Kodu Order Number	SK	d h6	D	A	L	€
533016	SK 30	16	38	40	17	47
533022	SK 30	22	48	40	19	47
533027	SK 30	27	58	50	21	47
533032	SK 30	32	78	50	24	50
534016	SK 40	16	38	35	17	45
534022	SK 40	22	48	35	19	45
534027	SK 40	27	58	40	21	45
534032	SK 40	32	78	50	24	48
534040	SK 40	40	88	50	27	55
535016	SK 50	16	38	35	17	78
535022	SK 50	22	48	35	19	69
535027	SK 50	27	58	40	21	69
535032	SK 50	32	78	50	24	74
535040	SK 50	40	88	50	27	80
535060	SK 50	60	128	70	40	162

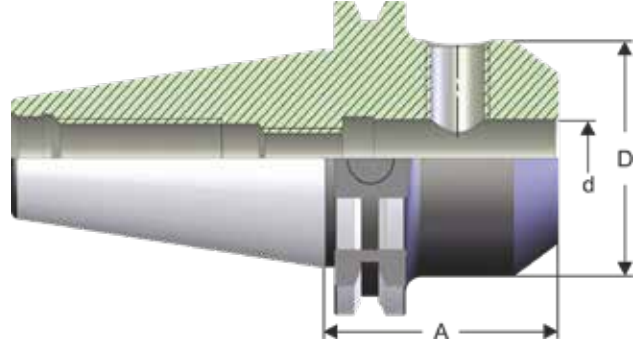
Sipariş Kodu
Order Number

SK

d
h4

D

A

€

543006

SK 30

6

25

50

41

543008

SK 30

8

28

50

39

543010

SK 30

10

35

50

39

543012

SK 30

12

42

50

39

543014

SK 30

14

44

63

39

543016

SK 30

16

48

63

39

543018

SK 30

18

50

63

39

543020

SK 30

20

52

70

39

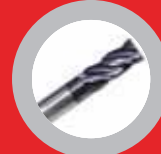
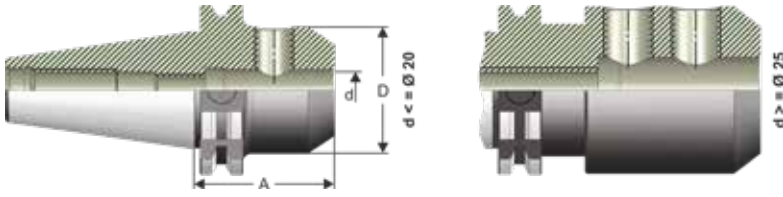

Sipariş Kodu Order Number	SK	d h4	D	A	€
544006	SK 40	6	25	50	38
544008	SK 40	8	28	50	36
544010	SK 40	10	35	50	36
544012	SK 40	12	42	50	36
544014	SK 40	14	44	50	36
544016	SK 40	16	48	63	36
544018	SK 40	18	50	63	36
544020	SK 40	20	52	63	36
544025	SK 40	25	63	100	48
544032	SK 40	32	72	100	50
544040	SK 40	40	79	120	55

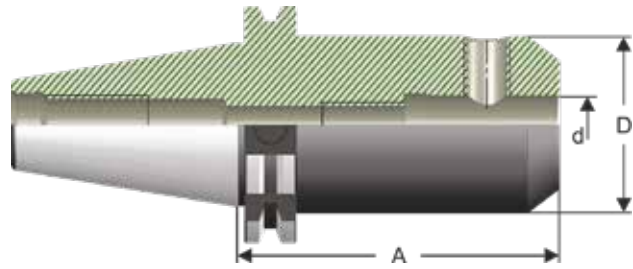

Sipariş Kodu Order Number	SK	d h4	D	A	€
544106	SK 40	6	25	100	49
544108	SK 40	8	28	100	48
544110	SK 40	10	35	100	48
544112	SK 40	12	42	100	48
544114	SK 40	14	44	100	48
544116	SK 40	16	48	100	48
544118	SK 40	18	50	100	48
544120	SK 40	20	52	100	48

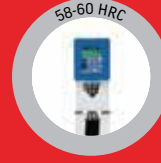
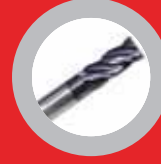
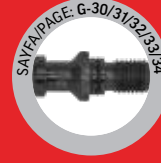
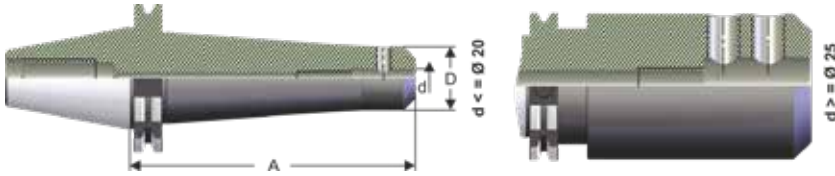

Sipariş Kodu Order Number	SK	d h4	D	A	€
544106.1	SK 40	6	25	160	69
544108.1	SK 40	8	28	160	67
544110.1	SK 40	10	35	160	67
544112.1	SK 40	12	42	160	67
544114.1	SK 40	14	44	160	67
544116.1	SK 40	16	48	160	67
544118.1	SK 40	18	50	160	67
544120.1	SK 40	20	52	160	67
544125.1	SK 40	25	63	160	76
544132.1	SK 40	32	72	160	80

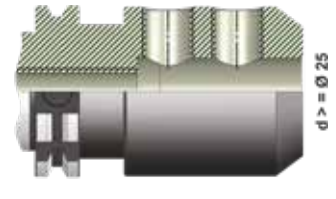
Sipariş Kodu
Order Number

SK

d
h4

D

A

€

545006

SK 50

6

25

63

62

545008

SK 50

8

28

63

56

545010

SK 50

10

35

63

56

545012

SK 50

12

42

63

56

545014

SK 50

14

44

63

56

545016

SK 50

16

48

63

56

545018

SK 50

18

50

63

56

545020

SK 50

20

52

63

56

545025

SK 50

25

65

80

62

545032

SK 50

32

72

100

66

545040

SK 50

40

80

110

69

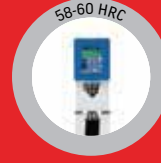
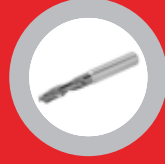
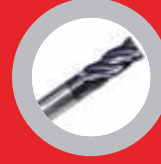
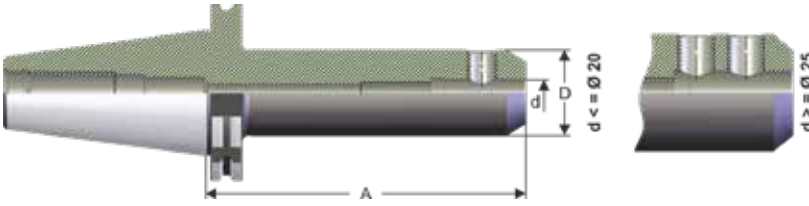

Sipariş Kodu Order Number	SK	d h4	D	A	€
545106	SK 50	6	25	160	95
545108	SK 50	8	28	160	95
545110	SK 50	10	35	160	95
545112	SK 50	12	42	160	95
545114	SK 50	14	44	160	95
545116	SK 50	16	48	160	95
545118	SK 50	18	50	160	95
545120	SK 50	20	52	160	95
545125	SK 50	25	65	160	99
545132	SK 50	32	72	160	104
545140	SK 50	40	80	160	110

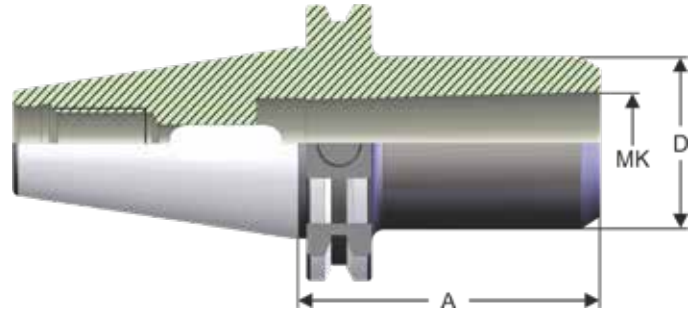

Sipariş Kodu Order Number	SK	Mk Morse	D	A	€
553001	SK 30	1	25	50	43
553002	SK 30	2	32	65	43
553003	SK 30	3	40	80	43
554001	SK 40	1	25	50	42
554002	SK 40	2	32	50	42
554003	SK 40	3	40	70	42
554004	SK 40	4	48	95	43
555001	SK 50	1	25	45	60
555002	SK 50	2	32	60	60
555003	SK 50	3	40	65	60
555004	SK 50	4	48	95	63
555005	SK 50	5	63	105	71

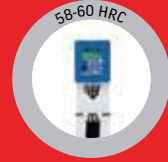
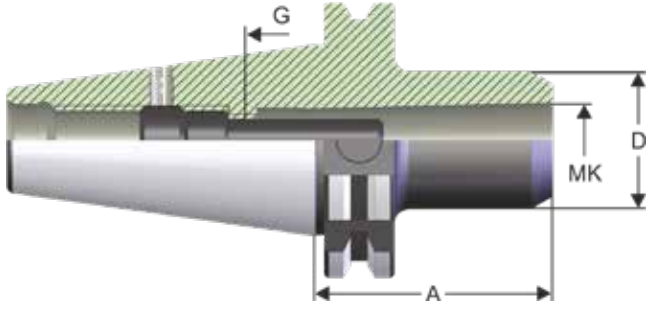

Sipariş Kodu Order Number	SK	Mk Morse	D	A	G	€
564001	SK 40	1	25	50	M6	52
564002	SK 40	2	32	55	M10	52
564003	SK 40	3	40	70	M12	52
564004	SK 40	4	48	95	M16	53
565001	SK 50	1	25	45	M6	81
565002	SK 50	2	32	60	M10	81
565003	SK 50	3	40	65	M12	81
565004	SK 50	4	48	85	M16	126
565005	SK 50	5	63	118	M20	140

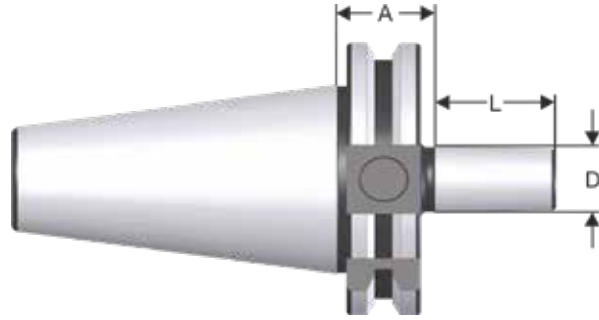

Sipariş Kodu Order Number	SK	D	A	L	€
573012	SK 30	B12	38,5	18,5	45
573016	SK 30	B16	40	24	45
574012	SK 40	B12	25	18,5	43
574016	SK 40	B16	25	24	43
574018	SK 40	B18	35	32	43
575016	SK 50	B16	25	24	62
575018	SK 50	B18	25	32	62

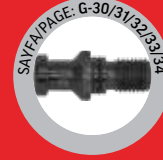
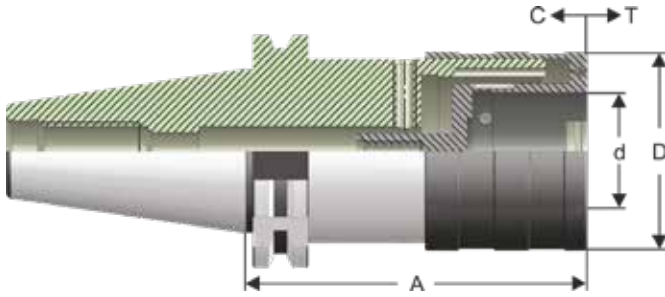

Sipariş Kodu Order Number	SK	Kapasite Capacity	d	A	D	C	T	€
576214	SK 30	M2 - M14	19	66	38	7	7	153
576524	SK 30	M5 - M24	31	99	54	12	12	201
577214	SK 40	M2 - M14	19	64	38	7	7	144
577524	SK 40	M5 - M24	31	97	54	12	12	189
5771436	SK 40	M14 - M36	48	136	78	17,5	17,5	291

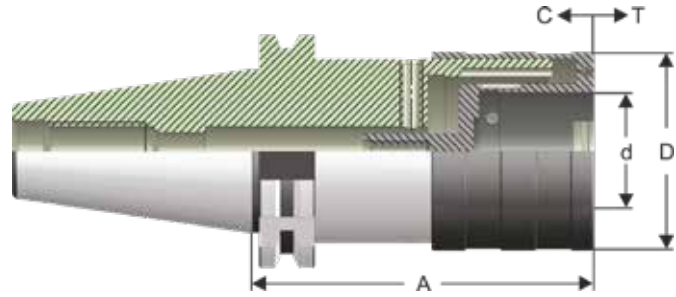

Sipariş Kodu Order Number	SK	Kapasite Capacity	d	A	D	C	T	€
578214	SK 50	M2 - M14	19	62	38	7	7	218
578524	SK 50	M5 - M24	31	85	54	12	12	260
5781436	SK 50	M14 - M36	48	138	78	17,5	17,5	357

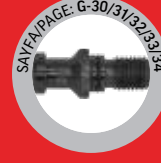
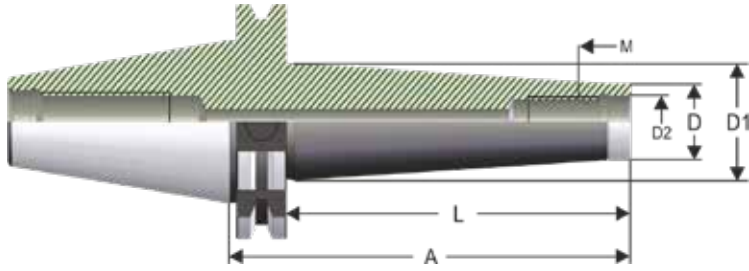

STANDART
BALANS
G 2,5
20000 min⁻¹

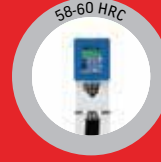
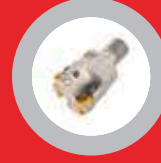

Sipariş Kodu Order Number	SK	M	D	D1	A	L	D2	€
584008	SK 40	M8	13	23	69	50	8,5	91
584008.1	SK 40	M8	13	25	119	100	8,5	119
584008.2	SK 40	M8	13	30	169	150	8,5	161
584010	SK 40	M10	18	23	69	50	10,5	91
584010.1	SK 40	M10	18	32	119	100	10,5	119
584010.2	SK 40	M10	18	36	169	150	10,5	161
584012	SK 40	M12	21	24	69	50	12,5	91
584012.1	SK 40	M12	21	33	119	100	12,5	119
584012.2	SK 40	M12	21	40	169	150	12,5	161
584016	SK 40	M16	29	34	94	75	17	104
584016.0	SK 40	M16	29	29	44	25	17	87
584016.1	SK 40	M16	29	40	144	125	17	154



STANDART
BALANS
G 2,5
20000 min⁻¹

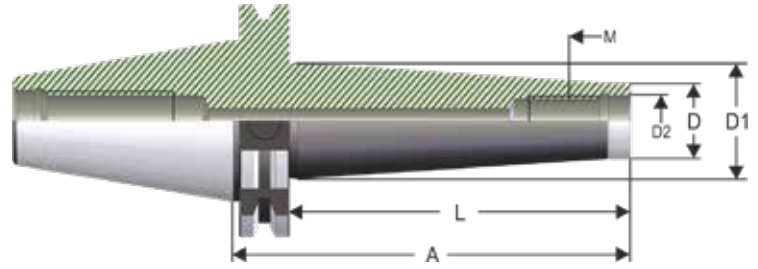
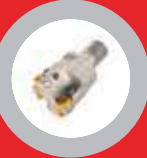

Sipariş Kodu Order Number	SK	M	D	D1	A	L	D2	€
585008	SK 50	M8	13	25	119	100	8,5	165
585008.1	SK 50	M8	13	30	169	150	8,5	213
585010	SK 50	M10	18	32	119	100	10,5	165
585010.1	SK 50	M10	18	36	169	150	10,5	213
585012	SK 50	M12	21	33	119	100	12,5	165
585012.1	SK 50	M12	21	40	169	150	12,5	213
585016	SK 50	M16	29	36	119	100	17	165
585016.1	SK 50	M16	29	42	169	150	17	213

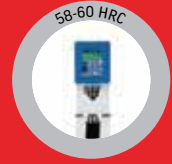
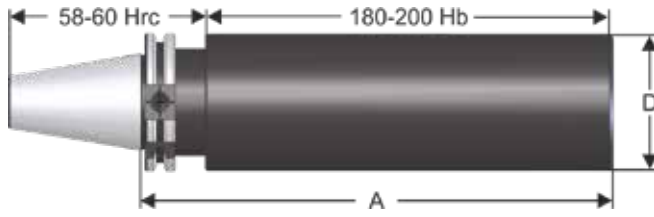

Sipariş Kodu
Order Number

SK

D

A

€

594000

SK 40

63

250

98

595000

SK 50

97

315

180



Sipariş Kodu Order Number	SK	Pens Collet	Adet Piece	Ölçüler Contents	€
593415	SK 30	415	16	3-4-5-6-7-8-9-10-11-12-13-14-15-16 - 904042 - 510415	306
593462	SK 30	462	18	4-5-6-7-8-9-10-11-12-14-16-18-20-22-24-25 - 905862 - 510462	410
594415	SK 40	415	16	3-4-5-6-7-8-9-10-11-12-13-14-15-16 - 904042 - 511415	301
594462	SK 40	462	18	4-5-6-7-8-9-10-11-12-14-16-18-20-22-24-25 - 905862 - 511462	406
594467	SK 40	467	18	5-6-7-8-10-12-14-16-18-20-22-24-25-28-30-32 - 906875 - 511467	567
595462	SK 50	462	18	4-5-6-7-8-9-10-11-12-14-16-18-20-22-24-25 - 905862 - 515462	428
595467	SK 50	467	18	5-6-7-8-10-12-14-16-18-20-22-24-25-28-30-32 - 906875 - 515467	581
595468	SK 50	468	22	6-7-8-9-10-12-14-16-18-20-22-24-25-28-30-32-34-36-38-40 - 908090 - 515468	997

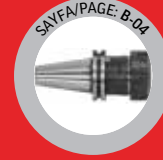

Sipariş Kodu Order Number	SK	Pens Collet	Adet Piece	Ölçüler Contents	€
593430	SK 30	430 /ER 25	14	3-4-5-6-7-8-9-10-11-12-14-16 - 9042430 - 510430	303
593470	SK 30	470 / ER 32	16	3-4-5-6-7-8-9-10-11-12-14-16-18-20 - 9050470 - 510470	309
593472	SK 30	472 / ER 40	18	4-5-6-7-8-9-10-11-12-14-16-18-20-22-24-26 - 9063472 - 510472	428
594430	SK 40	430 /ER 25	14	3-4-5-6-7-8-9-10-11-12-14-16 - 9042430 - 511430	300
594470	SK 40	470 / ER 32	16	3-4-5-6-7-8-9-10-11-12-14-16-18-20 - 9050470 - 511470	307
594472	SK 40	472 / ER 40	18	4-5-6-7-8-9-10-11-12-14-16-18-20-22-24-26 - 9063472 - 511472	425
595430	SK 50	430 /ER 25	14	3-4-5-6-7-8-9-10-11-12-14-16 - 9042430 - 515430	319
595470	SK 50	470 / ER 32	16	3-4-5-6-7-8-9-10-11-12-14-16-18-20 - 9050470 - 515470	326
595472	SK 50	472 / ER 40	18	4-5-6-7-8-9-10-11-12-14-16-18-20-22-24-26 - 9063472 - 515472	444

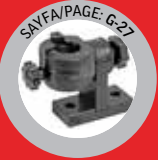

Sipariş Kodu Order Number	SK	Kapasite Capacity	Adet Piece	Ölçüler Contents	€
598420	SK 40	6-20	7	6-8-10-12-16 - 904550 - 518420	455
598432	SK 40	6-32	9	6-8-10-12-16-20-25-906875 - 518432	574
599520	SK 50	6-20	7	6-8-10-12-16 - 904550 - 519520	597
599532	SK 50	6-32	9	6-8-10-12-16-20-25-906875 - 519532	698

JIS B 6339 (MAS 403 BT)
BT TUTUCULAR
BT TOOLHOLDERS



BT TOOLHOLDERS

BT

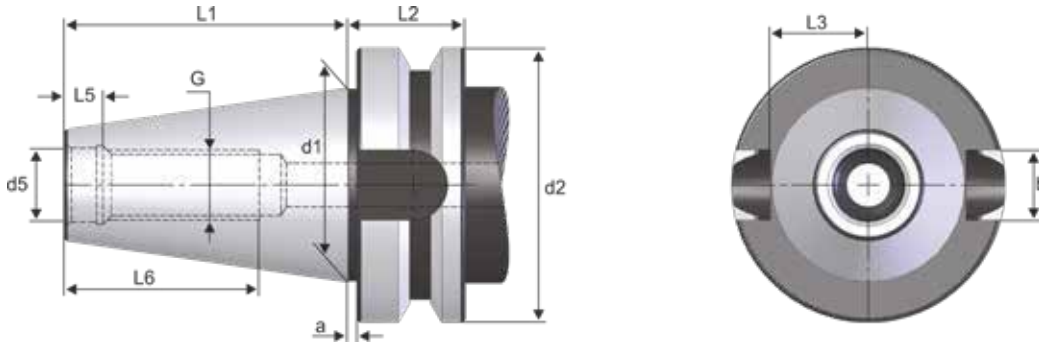

STANDART
BALANS
G 6,3
15000 min⁻¹



58-60 HRC



Ürün Adı Product Name	d1	G	d5	d2	a	L1	L2	L3	L5	L6	b
BT 30	31,75	M12	12,5	46	2	48,4	22	16,3	7	24	16,1
BT 40	44,45	M16	17	63	2	65,4	27	22,5	8,2	32	16,1
BT 50	69,85	M24	25	100	3	101,8	38	35,3	11	47	25,7

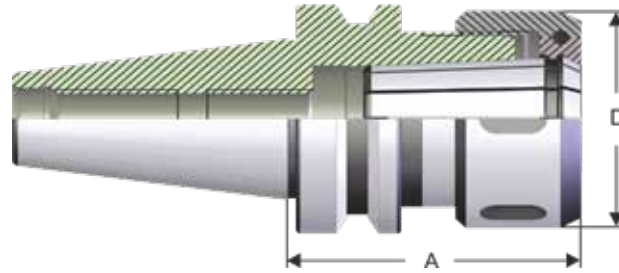

Sipariş Kodu Order Number	BT	Kapasite Capacity	D	A	€
310415	BT 30	415 (2-16)	43	60	69
310462	BT 30	462 (2-25)	60	80	70
311415	BT 40	415 (2-16)	43	70	64
311462	BT 40	462 (2-25)	60	70	66
311467	BT 40	467 (3-32)	72	90	77
315462	BT 50	462 (2-25)	60	85	94
315467	BT 50	467 (3-32)	72	90	98
315468	BT 50	468 (3-40)	85	100	143

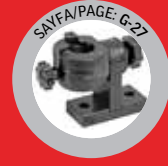
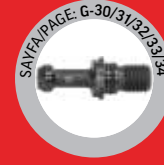
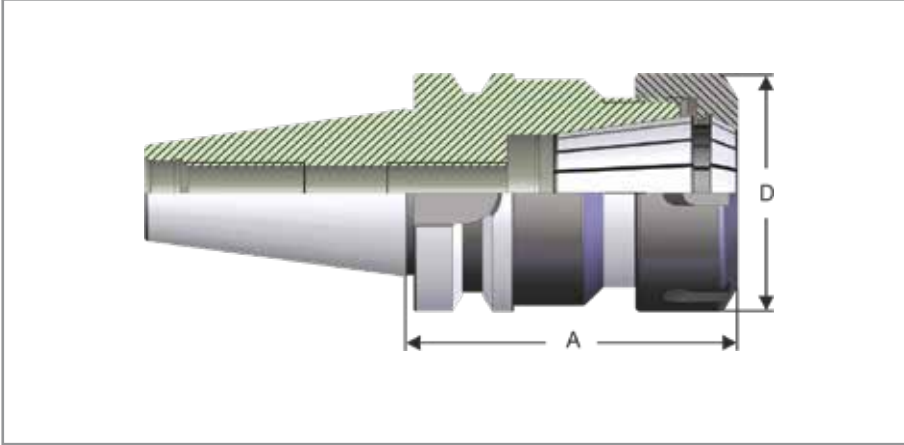

Sipariş Kodu Order Number	BT	Kapasite Capacity	D	A	€
310426	BT 30	ER 16 (2-10)	32	70	51
310430	BT 30	ER 25 (2-16)	42	70	53
310470	BT 30	ER 32 (2-20)	50	70	54
310472	BT 30	ER 40 (2-26)	63	70	58
311426	BT 40	ER 16 (2-10)	32	63	49
311430	BT 40	ER 25 (2-16)	42	60	50
311470	BT 40	ER 32 (2-20)	50	70	52
311472	BT 40	ER 40 (2-26)	63	80	55
315426	BT 50	ER 16 (2-10)	32	70	66
315430	BT 50	ER 25 (2-16)	42	70	69
315470	BT 50	ER 32 (2-20)	50	70	71
315472	BT 50	ER 40 (2-26)	63	80	74

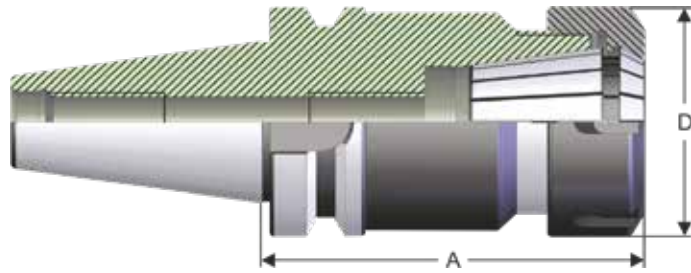
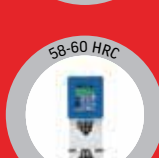
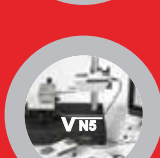

Sipariş Kodu Order Number	BT	Kapasite Capacity	D	A	€
310426-1	BT 30	ER 16 (2-10)	32	100	61
310426-2	BT 30	ER 16 (2-10) MİNİ	22	100	82
310430-1	BT 30	ER 25 (2-16)	42	100	63
310470-1	BT 30	ER 32 (2-20)	50	100	65
310472-1	BT 30	ER 40 (2-26)	63	100	69
312426	BT 40	ER 16 (2-10)	32	100	57
312426-1	BT 40	ER 16 (2-10) MİNİ	22	100	74
312430	BT 40	ER 25 (2-16)	42	100	59
312470	BT 40	ER 32 (2-20)	50	100	62
312472	BT 40	ER 40 (2-26)	63	100	66
316426	BT 50	ER 16 (2-10)	32	100	81
316430	BT 50	ER 25 (2-16)	42	100	83
316470	BT 50	ER 32 (2-20)	50	100	84
316472	BT 50	ER 40 (2-26)	63	100	89

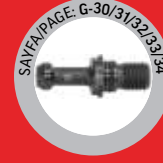
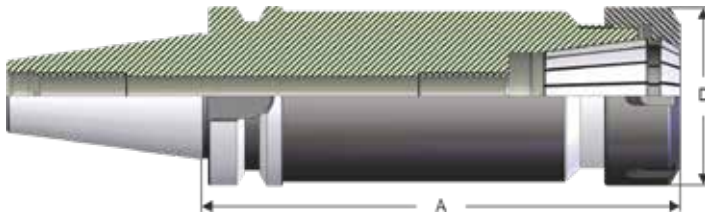

Sipariş Kodu Order Number	BT	Kapasite Capacity	D	A	€
310426-3	BT 30	ER 16 (2-10)	32	160	100
313426	BT 40	ER 16 (2-10)	32	160	73
313430	BT 40	ER 25 (2-16)	42	160	73
313470	BT 40	ER 32 (2-20)	50	160	76
313472	BT 40	ER 40 (2-26)	63	160	85
317426	BT 50	ER 16 (2-10)	32	160	105
317430	BT 50	ER 25 (2-16)	42	160	105
317470	BT 50	ER 32 (2-20)	50	160	105
317472	BT 50	ER 40 (2-26)	63	160	114

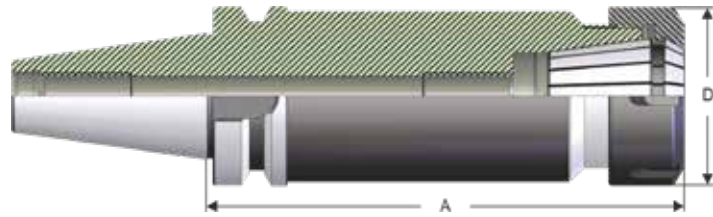
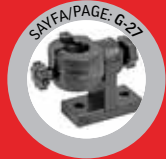

Sipariş Kodu Order Number	BT	Kapasite Capacity	D	A	€
313426-1	BT 40	ER 16 MİNİ (2-10)	22	160	104
317426-1	BT 50	ER 16 MİNİ (2-10)	22	160	168
316472-1	BT 50	ER 40 (2-26)	63	130	102
317472-1	BT 50	ER 40 (2-26)	63	200	150

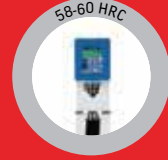
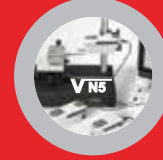
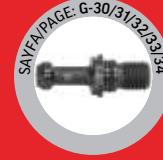
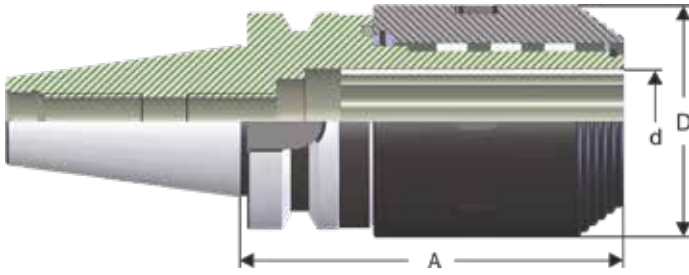

Sipariş Kodu Order Number	BT	Kapasite Capacity (d)	A	D	€
318420	BT 40	6-20 mm	75	49	277
318432	BT 40	6-32 mm	90	68	308
319520	BT 50	6-20 mm	90	49	413
319532	BT 50	6-32 mm	95	68	420

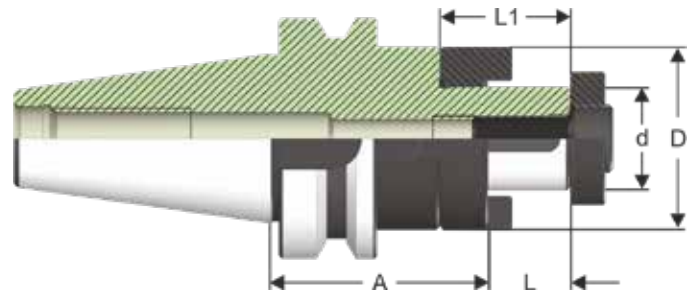
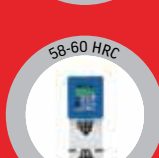
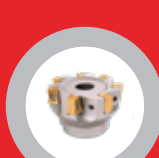
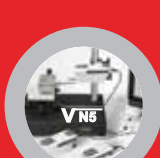
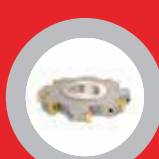

Sipariş Kodu Order Number	BT	d h6	D	A	L	L1	€
323016	BT 30	16	32	45	17	27	50
323022	BT 30	22	40	47	19	31	50
323027	BT 30	27	48	49	21	33	50
324016	BT 40	16	32	55	17	27	48
324022	BT 40	22	40	55	19	31	48
324027	BT 40	27	48	55	21	33	48
324032	BT 40	32	58	60	24	38	50
324040	BT 40	40	70	60	27	41	57
325016	BT 50	16	32	70	17	27	63
325022	BT 50	22	40	70	19	31	63
325027	BT 50	27	48	70	21	33	65
325032	BT 50	32	58	70	24	38	71
325040	BT 50	40	70	70	27	41	78

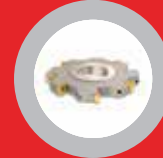
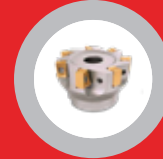
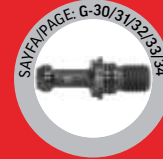
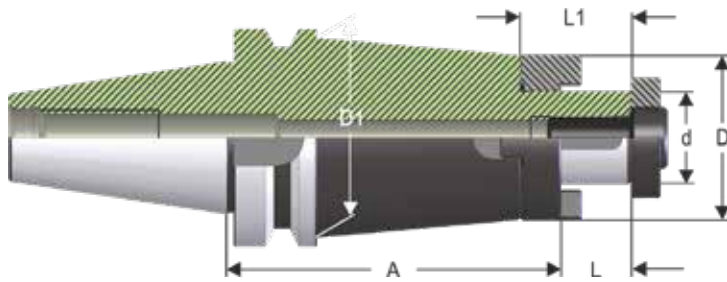

Sipariş Kodu Order Number	BT	d h6	D	A	L	L1	D1	€
324116	BT 40	16	32	100	17	27	38	59
324122	BT 40	22	40	100	19	31	48	59
324127	BT 40	27	48	100	21	33	58	59
324132	BT 40	32	58	100	24	38	61	64
324140	BT 40	40	70	100	27	41	70	69
325116	BT 50	16	32	100	17	27	38	87
325122	BT 50	22	40	100	19	31	48	87
325127	BT 50	27	48	100	21	33	58	89
325132	BT 50	32	58	100	24	38	68	93
325140	BT 50	40	70	100	27	41	80	98

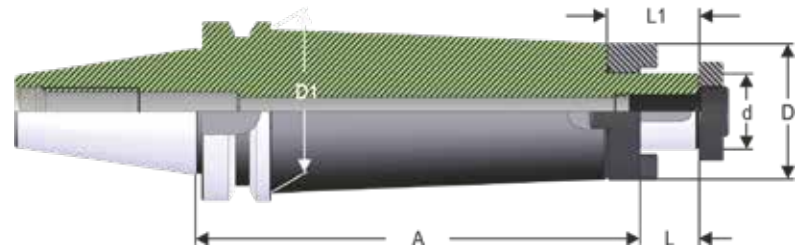
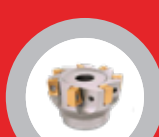

Sipariş Kodu Order Number	BT	d h6	D	A	L	L1	D1	€
324116.1	BT 40	16	32	160	17	27	38	98
324122.1	BT 40	22	40	160	19	31	48	98
324127.1	BT 40	27	48	160	21	33	58	98
324132.1	BT 40	32	58	160	24	38	61	102
324140.1	BT 40	40	70	160	27	41	70	108
325116.1	BT 50	16	32	160	17	27	38	131
325122.1	BT 50	22	40	160	19	31	48	131
325127.1	BT 50	27	48	160	21	33	58	131
325132.1	BT 50	32	58	160	24	38	68	138
325140.1	BT 50	40	70	160	27	41	80	150

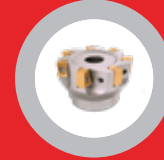
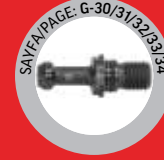
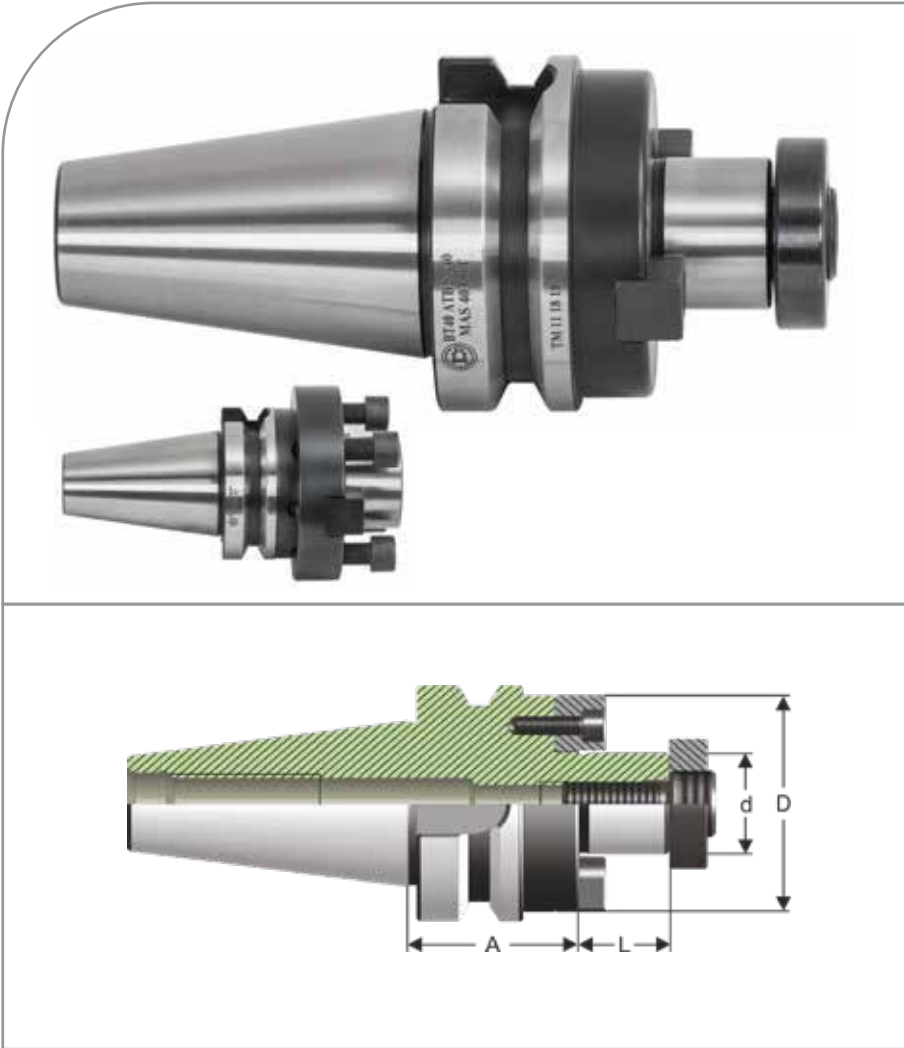

Sipariş Kodu Order Number	BT	d h6	D	A	L	€
333016	BT 30	16	38	40	17	47
333022	BT 30	22	48	40	19	47
333027	BT 30	27	58	40	21	47
334016	BT 40	16	38	40	17	45
334022	BT 40	22	48	40	19	45
334027	BT 40	27	58	40	21	45
334032	BT 40	32	78	50	24	48
334040	BT 40	40	88	50	27	55
335016	BT 50	16	38	55	17	69
335022	BT 50	22	48	55	19	69
335027	BT 50	27	58	55	21	69
335032	BT 50	32	78	55	24	74
335040	BT 50	40	88	55	27	80
335060	BT 50	60	128	88	40	162

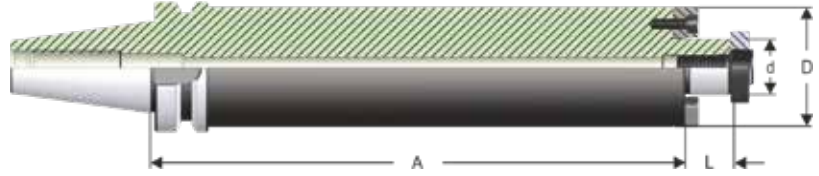
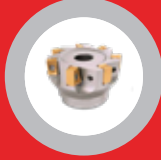

Sipariş Kodu Order Number	BT	d h6	D	A	L	€
334322	BT 40	22	61	250	19	180
334327	BT 40	27	61	250	21	183
334332	BT 40	32	78	250	24	192
335322	BT 50	22	61	250	19	294
335327	BT 50	27	61	250	21	294
335332	BT 50	32	78	250	24	308

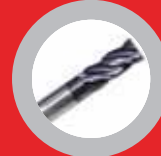
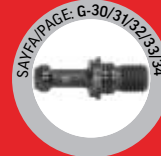
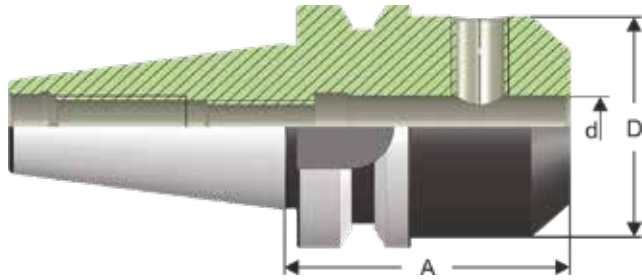

Sipariş Kodu Order Number	BT	d h4	D	A	€
343006	BT 30	6	25	50	41
343008	BT 30	8	28	50	39
343010	BT 30	10	35	50	39
343012	BT 30	12	42	50	39
343014	BT 30	14	44	63	39
343016	BT 30	16	48	63	39
343018	BT 30	18	50	63	39
343020	BT 30	20	52	63	39

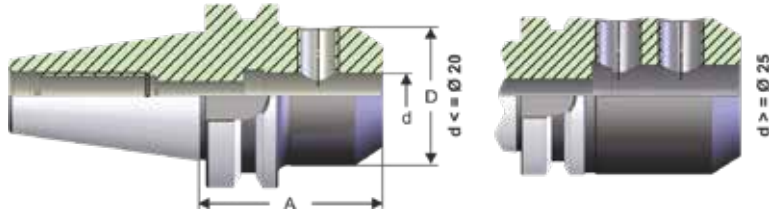

Sipariş Kodu
Order Number

BT

d
h4

D

A

€

344006

BT 40

6

25

50

38

344008

BT 40

8

28

50

36

344010

BT 40

10

35

63

36

344012

BT 40

12

42

63

36

344014

BT 40

14

44

63

36

344016

BT 40

16

48

63

36

344018

BT 40

18

50

63

36

344020

BT 40

20

52

63

36

344025

BT 40

25

63

90

48

344032

BT 40

32

72

100

50

344040

BT 40

40

79

120

55

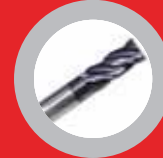
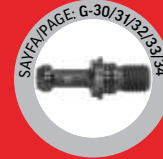
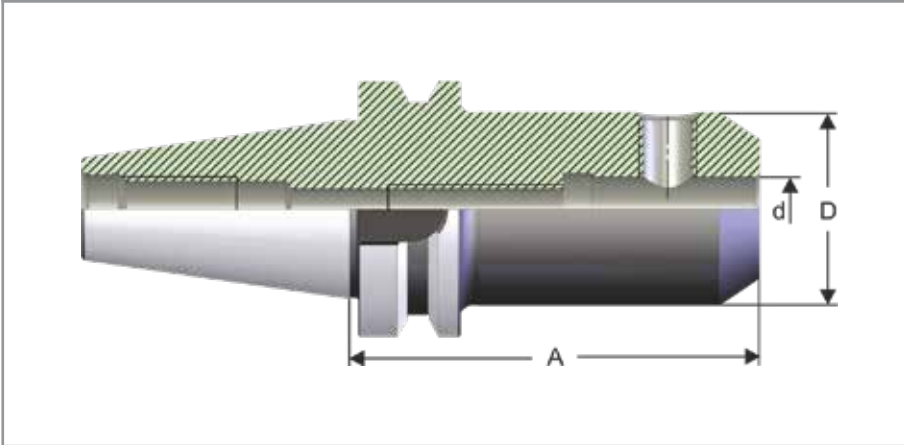

Sipariş Kodu Order Number	BT	d h4	D	A	€
344106	BT 40	6	25	100	49
344108	BT 40	8	28	100	48
344110	BT 40	10	35	100	48
344112	BT 40	12	42	100	48
344114	BT 40	14	44	100	48
344116	BT 40	16	48	100	48
344118	BT 40	18	50	100	48
344120	BT 40	20	52	100	48

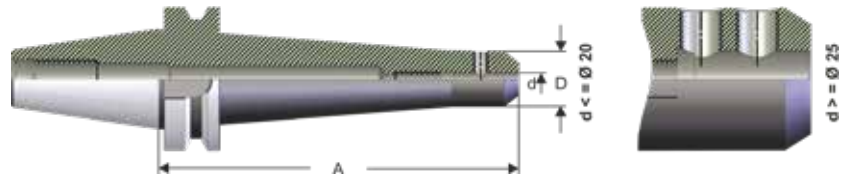
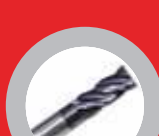
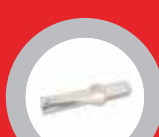
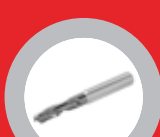

Sipariş Kodu Order Number	BT	d h4	D	A	€
344106.1	BT 40	6	25	160	69
344108.1	BT 40	8	28	160	67
344110.1	BT 40	10	35	160	67
344112.1	BT 40	12	42	160	67
344114.1	BT 40	14	44	160	67
344116.1	BT 40	16	48	160	67
344118.1	BT 40	18	50	160	67
344120.1	BT 40	20	52	160	67
344125.1	BT 40	25	63	160	76
344132.1	BT 40	32	72	160	80

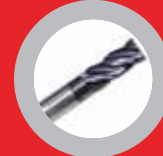
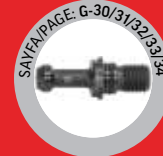
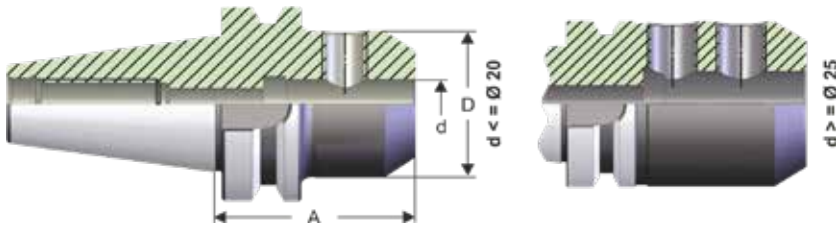

Sipariş Kodu Order Number	BT	d h4	D	A	€
345006	BT 50	6	25	63	62
345008	BT 50	8	28	63	56
345010	BT 50	10	35	63	56
345012	BT 50	12	42	80	56
345014	BT 50	14	44	80	56
345016	BT 50	16	48	80	56
345018	BT 50	18	50	80	56
345020	BT 50	20	52	80	56
345025	BT 50	25	65	100	62
345032	BT 50	32	72	105	66
345040	BT 50	40	80	110	69

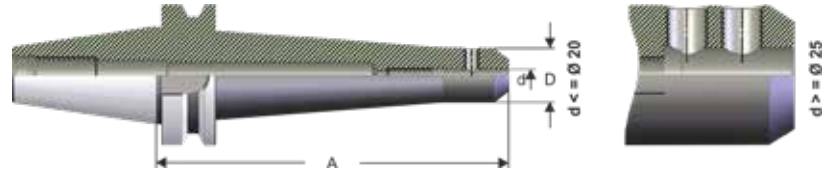

Sipariş Kodu Order Number	BT	d h4	D	A	€
345106	BT 50	6	25	160	95
345108	BT 50	8	28	160	95
345110	BT 50	10	35	160	95
345112	BT 50	12	42	160	95
345116	BT 50	16	48	160	95
345120	BT 50	20	52	160	95
345125	BT 50	25	65	160	99
345132	BT 50	32	72	160	104
345140	BT 50	40	80	160	108

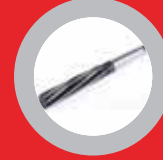
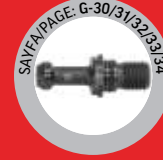
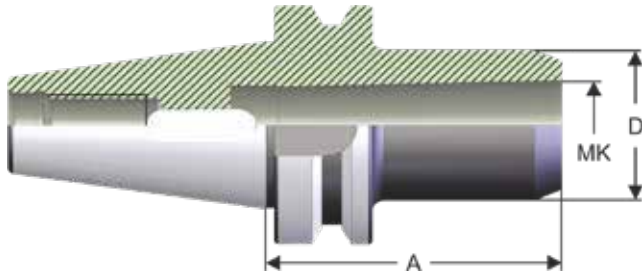

Sipariş Kodu Order Number	BT	Mk Morse	D	A	€
353001	BT 30	1	25	45	43
353002	BT 30	2	32	60	43
353003	BT 30	3	40	75	43
354001	BT 40	1	25	50	42
354002	BT 40	2	32	50	42
354003	BT 40	3	40	70	42
354004	BT 40	4	48	95	43
355001	BT 50	1	25	45	60
355002	BT 50	2	32	60	60
355003	BT 50	3	40	65	60
355004	BT 50	4	48	95	63
355005	BT 50	5	63	105	71

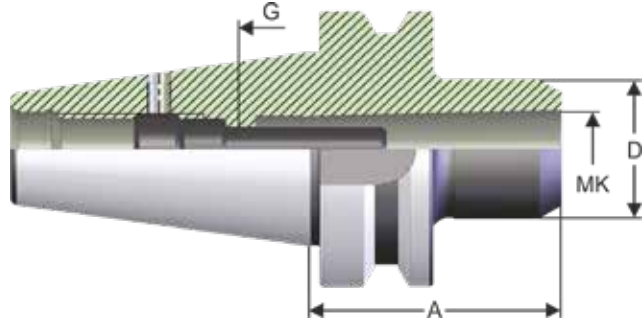

Sipariş Kodu Order Number	BT	Mk Morse	D	A	G	€
364001	BT 40	1	25	50	M6	52
364002	BT 40	2	32	55	M10	52
364003	BT 40	3	40	70	M12	52
364004	BT 40	4	48	95	M16	59
365001	BT 50	1	25	45	M6	81
365002	BT 50	2	32	60	M10	81
365003	BT 50	3	40	65	M12	81
365004	BT 50	4	48	85	M16	126
365005	BT 50	5	63	118	M20	140

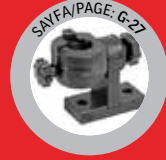
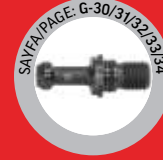
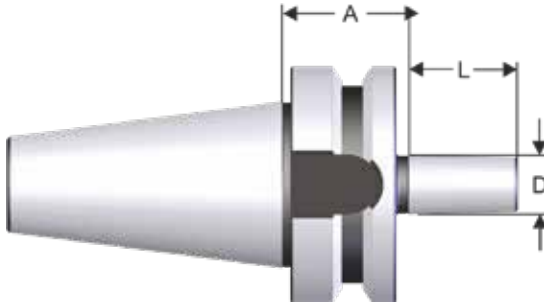

Sipariş Kodu
Order Number

BT

D

A

L

€

373012

BT 30

B12

25

18,5

45

373016

BT 30

B16

25

24

45

374012

BT 40

B12

32

18,5

43

374016

BT 40

B16

32

24

43

374018

BT 40

B18

32

32

43

375016

BT 50

B16

43

24

62

375018

BT 50

B18

43

32

62

JIS B 6339 (MAS 403 BT)

KLAVUZ ÇEKME BAŞLIĞI GİRİŞ VE ÇIKIŞ KOMPANZİYELİ

QUICK-CHANGE TAPPING CHUCKS WITH LENGTH COMPENSATION

DEĞERLİ[®]
www.degerlimakina.com

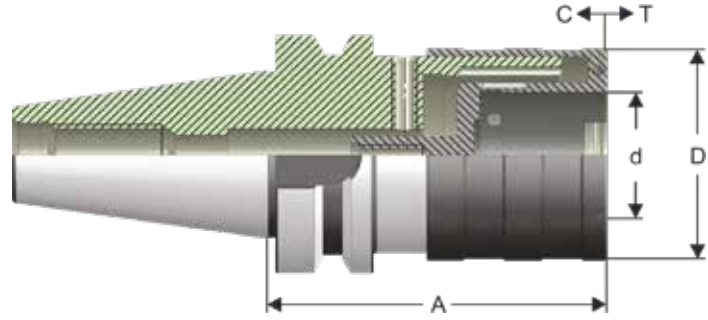
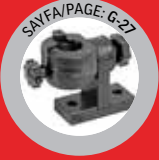

Sipariş Kodu Order Number	BT	Kapasite Capacity	d	A	D	C	T	€
376214	BT 30	M2 - M14	19	64	38	7	7	153
376524	BT 30	M5 - M24	31	95	54	12	12	201

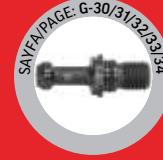
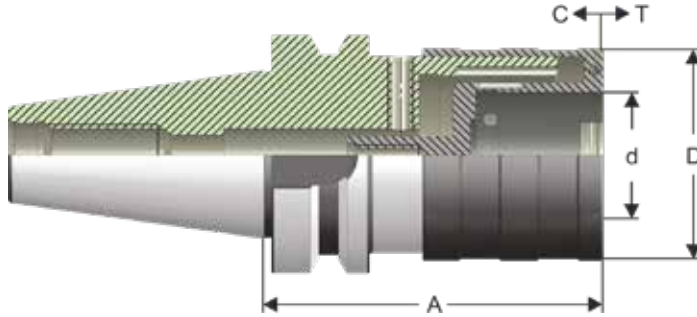

Sipariş Kodu Order Number	BT	Kapasite Capacity	d	A	D	C	T	€
377214	BT 40	M2 - M14	19	67	38	7	7	144
377524	BT 40	M5 - M24	31	93	54	12	12	189
3771436	BT 40	M14 - M36	48	136	78	17,5	17,5	291
378214	BT 50	M2 - M14	19	82	38	7	7	218
378524	BT 50	M5 - M24	31	102	54	12	12	260
3781436	BT 50	M14 - M36	48	142	78	17,5	17,5	357

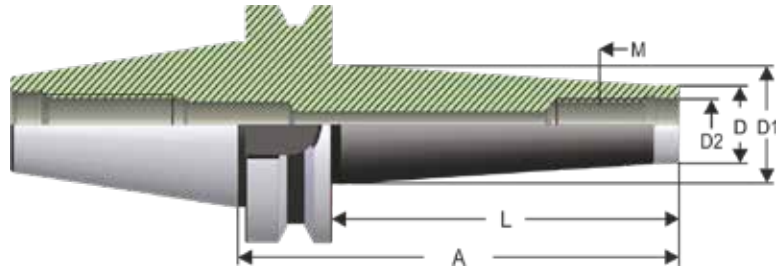
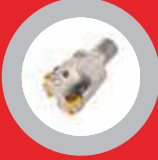

Sipariş Kodu Order Number	BT	M	D	D1	A	L	D2	€
384008	BT 40	M8	13	23	77	50	8,5	91
384008.1	BT 40	M8	13	25	127	100	8,5	119
384008.2	BT 40	M8	13	30	177	150	8,5	147
384010	BT 40	M10	18	23	77	50	10,5	91
384010.1	BT 40	M10	18	32	127	100	10,5	119
384010.2	BT 40	M10	18	36	177	150	10,5	147
384012	BT 40	M12	21	25	77	50	12,5	91
384012.1	BT 40	M12	21	32	127	100	12,5	119
384012.2	BT 40	M12	21	40	177	150	12,5	151
384016	BT 40	M16	29	34	102	75	17	104
384016.0	BT 40	M16	29	-	52	25	17	87
384016.1	BT 40	M16	29	40	152	125	17	143

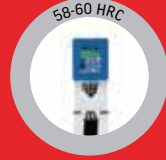
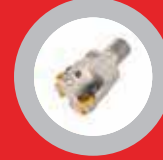
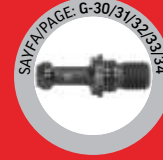
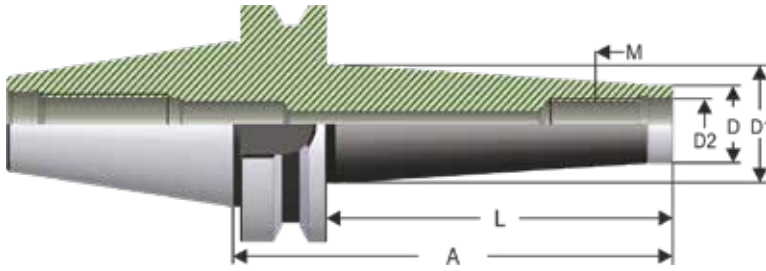

Sipariş Kodu Order Number	BT	M	D	D1	A	L	D2	€
385008	BT 50	M8	13	25	138	100	8,5	165
385008.1	BT 50	M8	13	30	188	150	8,5	213
385010	BT 50	M10	18	32	138	100	10,5	165
385010.1	BT 50	M10	18	36	188	150	10,5	213
385012	BT 50	M12	21	33	138	100	12,5	165
385012.1	BT 50	M12	21	40	188	150	12,5	213
385016	BT 50	M16	29	36	138	100	17	165
385016.1	BT 50	M16	29	42	188	150	17	213

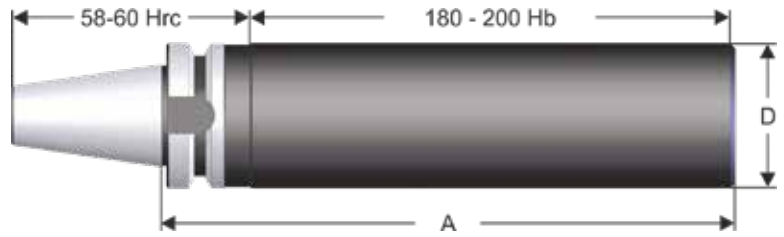
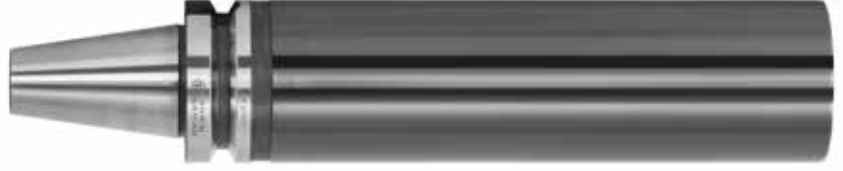
**Sipariş Kodu**
Order Number**BT****D****A****€**

394000

BT 40

63

250

98

395000

BT 50

97

315

180

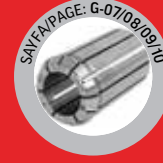

Sipariş Kodu Order Number	BT	Pens Collet	Adet Piece	Ölçüler Contents	€
393415	BT 30	415	16	3-4-5-6-7-8-9-10-11-12-13-14-15-16-904042-310415	306
393462	BT 30	462	18	4-5-6-7-8-9-10-11-12-14-16-18-20-22-24-25-905862 - 310462	410
394415	BT 40	415	16	3-4-5-6-7-8-9-10-11-12-13-14-15-16-904042-311415	301
394462	BT 40	462	18	4-5-6-7-8-9-10-11-12-14-16-18-20-22-24-25-905862 - 311462	406
394467	BT 40	467	18	5-6-7-8-10-12-14-16-18-20-22-24-25-28-30-32-906875 - 311467	567
395462	BT 50	462	18	4-5-6-7-8-9-10-11-12-14-16-18-20-22-24-25-905862 - 315462	434
395467	BT 50	467	18	5-6-7-8-10-12-14-16-18-20-22-24-25-28-30-32-906875 - 315467	588
395468	BT 50	468	22	6-7-8-9-10-12-14-16-18-20-22-24-25-28-30-32-34-36-38-40-908090-315468	993



SAYFA/PAGE: G-04



SAYFA/PAGE: G-29



SAYFA/PAGE: G-26



SAYFA/PAGE: G-19



SAYFA/PAGE: G-02/03/04/05/06



SAYFA/PAGE: G-43

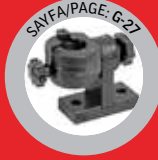

SAYFA/PAGE: G-27



Sipariş Kodu Order Number	BT	Pens Collet	Adet Piece	Ölçüler Contents	€
393430	BT 30	430 / ER 25	14	3-4-5-6-7-8-9-10-11-12-14-16 - 9042430 - 310430	303
393470	BT 30	470 / ER 32	16	3-4-5-6-7-8-9-10-11-12-14-16-18-20 - 9050470 - 310470	309
393472	BT 30	472 / ER 40	18	4-5-6-7-8-9-10-11-12-14-16-18-20-22-24-26 - 9063472 - 310472	428
394430	BT 40	430 / ER 25	14	3-4-5-6-7-8-9-10-11-12-14-16 - 9042430 - 311430	300
394470	BT 40	470 / ER 32	16	3-4-5-6-7-8-9-10-11-12-14-16-18-20 - 9050470 - 311470	307
394472	BT 40	472 / ER 40	18	4-5-6-7-8-9-10-11-12-14-16-18-20-22-24-26 - 9063472 - 311472	425
395430	BT 50	430 / ER 25	14	3-4-5-6-7-8-9-10-11-12-14-16 - 9042430 - 315430	319
395470	BT 50	470 / ER 32	16	3-4-5-6-7-8-9-10-11-12-14-16-18-20 - 9050470 - 315470	326
395472	BT 50	472 / ER 40	18	4-5-6-7-8-9-10-11-12-14-16-18-20-22-24-26 - 9063472 - 315472	444

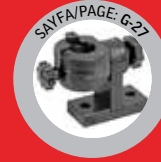

Sipariş Kodu Order Number	BT	Kapasite Capacity	Adet Piece	Ölçüler Contents	€
398420	BT 40	6-20	7	6-8-10-12-16 - 904550 - 318420	455
398432	BT 40	6-32	9	6-8-10-12-16-20-25- 906875 - 318432	574
399520	BT 50	6-20	7	6-8-10-12-16 - 904550 - 319520	597
399532	BT 50	6-32	9	6-8-10-12-16-20-25- 906875 - 319532	698

BBT TOOLHOLDERS



JIS B 6339 (MAS 403 BBT)
BBT TUTUCULAR
BBT TOOLHOLDERS

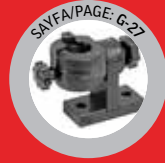
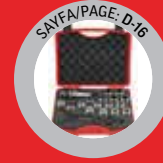
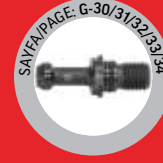
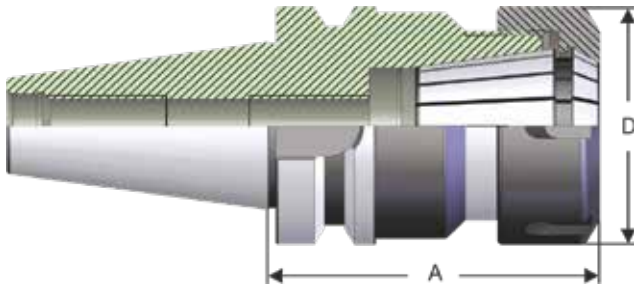

Sipariş Kodu Order Number	BBT	Kapasite Capacity	D	A	€
311426.DGP	BBT - 40	ER 16 (2-10)	32	63	71
311430.DGP	BBT - 40	ER 25 (2-16)	42	60	74
311470.DGP	BBT - 40	ER 32 (2-20)	50	70	76
311472.DGP	BBT - 40	ER 40 (2-26)	63	80	80
315426.DGP	BBT - 50	ER 16 (2-10)	32	70	96
315430.DGP	BBT - 50	ER 25 (2-16)	42	70	101
315470.DGP	BBT - 50	ER 32 (2-20)	50	70	104
315472.DGP	BBT - 50	ER 40 (2-26)	63	80	108
315467.DGP	BBT - 50	467 (3 - 32)	72	90	143

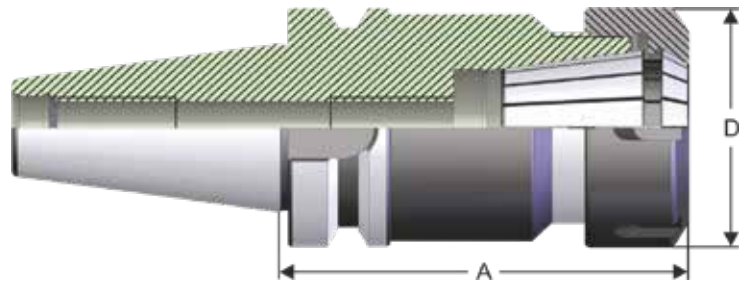

Sipariş Kodu Order Number	BBT	Kapasite Capacity	D	A	€
312426.DGP	BBT 40	ER 16 (2-10)	32	100	84
312426-1.DGP	BBT 40	ER 16 MİNİ (2-10)	22	100	92
312430.DGP	BBT 40	ER 25 (2-16)	42	100	85
312470.DGP	BBT 40	ER 32 (2-20)	50	100	90
312472.DGP	BBT 40	ER 40 (2-26)	63	100	97
316426.DGP	BBT 50	ER 16 (2-10)	32	100	119
316430.DGP	BBT 50	ER 25 (2-16)	42	100	120
316470.DGP	BBT 50	ER 32 (2-20)	50	100	123
316472.DGP	BBT 50	ER 40 (2-26)	63	100	129
316472-1.DGP	BBT 50	ER 40 (2-26)	63	130	147

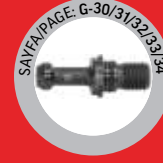
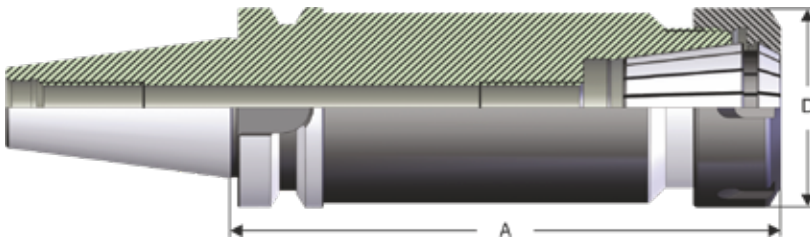

Sipariş Kodu Order Number	BBT	Kapasite Capacity	D	A	€
313426.DGP	BBT 40	ER 16 (2-10)	32	160	106
313426-1.DGP	BBT 40	ER 16 MİNİ (2-10)	22	160	126
313430.DGP	BBT 40	ER 25 (2-16)	42	160	106
313470.DGP	BBT 40	ER 32 (2-20)	50	160	111
313472.DGP	BBT 40	ER 40 (2-26)	63	160	125
317426.DGP	BBT 50	ER 16 (2-10)	32	160	153
317426-1.DGP	BBT 50	ER 16 MİNİ (2-10)	22	160	182
317426-2.DGP	BBT 50	ER 16 (2-10)	32	200	168
317430.DGP	BBT 50	ER 25 (2-16)	42	160	153
317470.DGP	BBT 50	ER 32 (2-20)	50	160	153
317472.DGP	BBT 50	ER 40 (2-26)	63	160	165
317472-1.DGP	BBT 50	ER 40 (2-26)	63	200	197

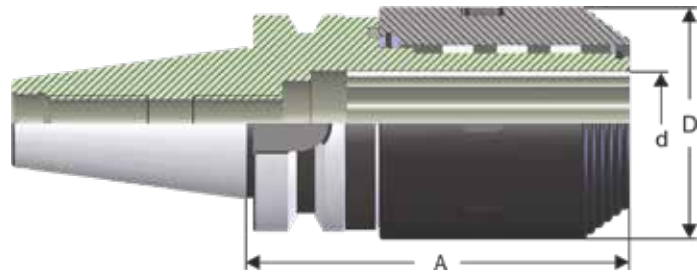

Sipariş Kodu Order Number	BBT	Kapasite Capacity (d)	A	D	€
318420.DGP	BBT 40	6-20 mm	75	49	403
318432.DGP	BBT 40	6-32 mm	90	68	447
319520.DGP	BBT 50	6-20 mm	90	49	584
319532.DGP	BBT 50	6-32 mm	95	68	609

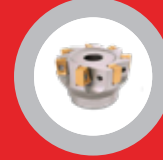
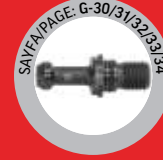
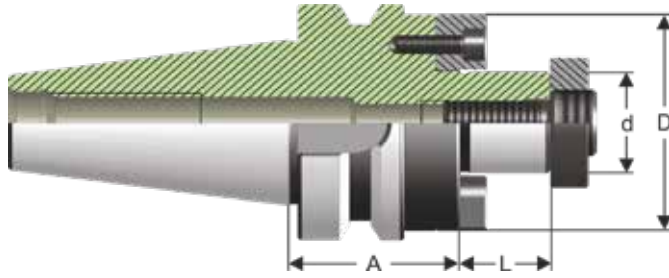

Sipariş Kodu Order Number	BBT	d h6	D	A	L	€
334016.DGP	BBT 40	16	38	40	17	66
334022.DGP	BBT 40	22	48	40	19	66
334027.DGP	BBT 40	27	58	40	21	66
334032.DGP	BBT 40	32	78	50	24	70
334040.DGP	BBT 40	40	88	50	27	80
335016.DGP	BBT 50	16	38	55	17	101
335022.DGP	BBT 50	22	48	55	19	101
335027.DGP	BBT 50	27	58	55	21	101
335032.DGP	BBT 50	32	78	55	24	108
335040.DGP	BBT 50	40	88	55	27	116
335060.DGP	BBT 50	60	128	80	40	236

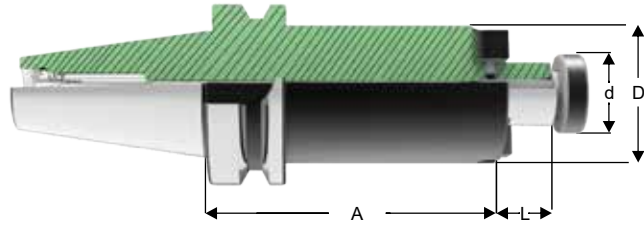

Sipariş Kodu Order Number	BBT	d h6	D	A	L	€
334116.DGP	BBT 40	16	38	100	17	94
334122.DGP	BBT 40	22	48	100	19	94
334127.DGP	BBT 40	27	58	100	21	94
334132.DGP	BBT 40	32	78	100	24	98
334140.DGP	BBT 40	40	88	100	27	108
335116.DGP	BBT 50	16	38	100	17	125
335122.DGP	BBT 50	22	48	100	19	125
335127.DGP	BBT 50	27	58	100	21	125
335132.DGP	BBT 50	32	78	100	24	135
335140.DGP	BBT 50	40	88	100	27	147

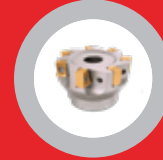
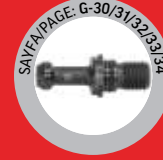
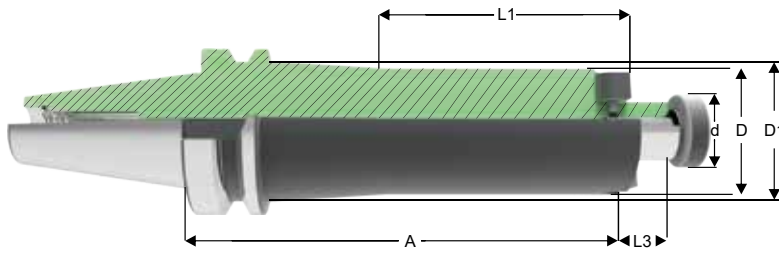

Sipariş Kodu Order Number	BBT	d h6	D	A	L1	L3	D1	€
334116.1.DGP	BBT 40	16	38	160	88	17	44,5	141
334122.1.DGP	BBT 40	22	48	160	-	19	-	141
334127.1.DGP	BBT 40	27	58	160	-	21	-	141
334132.1.DGP	BBT 40	32	78	160	-	24	-	155
334140.1.DGP	BBT 40	40	88	160	-	27	-	168
335116.1.DGP	BBT 50	16	38	130	-	17	-	155
335122.1.DGP	BBT 50	22	48	130	-	19	-	155
335127.1.DGP	BBT 50	27	58	130	-	21	-	155
335132.1.DGP	BBT 50	32	78	130	-	24	-	155
335140.1.DGP	BBT 50	40	88	130	-	27	-	155

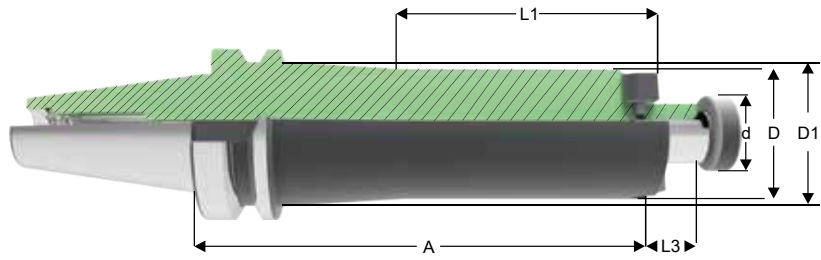
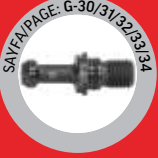

Sipariş Kodu Order Number	BBT	d h6	D	A	L1	L3	D1	€
335116.2.DGP	BBT 50	16	38	160	88	17	43	191
335122.2.DGP	BBT 50	22	48	160	88	19	53,5	191
335127.2.DGP	BBT 50	27	58	160	88	21	63,5	191
335132.2.DGP	BBT 50	32	78	160	-	24	-	197
335140.2.DGP	BBT 50	40	88	160	-	27	-	210
335116.3.DGP	BBT 50	16	38	200	88	17	47	240
335122.3.DGP	BBT 50	22	48	200	120	19	54,5	240
335127.3.DGP	BBT 50	27	58	200	120	21	64,5	240
335132.3.DGP	BBT 50	32	78	200	-	24	-	254
335140.3.DGP	BBT 50	40	88	200	-	27	-	309

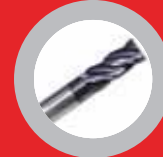
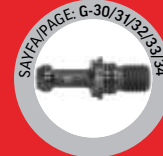
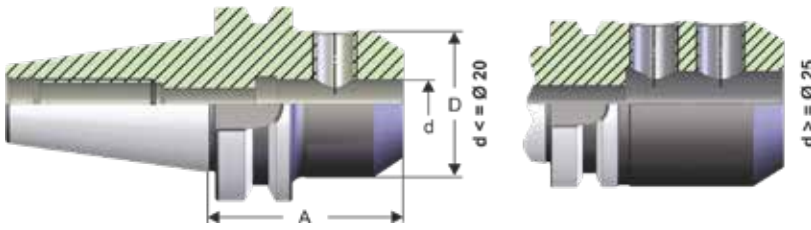

Sipariş Kodu Order Number	BBT	d h4	D	A	€
344006.DGP	BBT 40	6	25	50	56
344008.DGP	BBT 40	8	28	50	53
344010.DGP	BBT 40	10	35	63	53
344012.DGP	BBT 40	12	42	63	53
344014.DGP	BBT 40	14	44	63	53
344016.DGP	BBT 40	16	48	63	53
344016.0.DGP	BBT 40	16	48	35	66
344018.DGP	BBT 40	18	50	63	53
344020.DGP	BBT 40	20	52	63	53
344020.0.DGP	BBT 40	20	52	35	66
344025.DGP	BBT 40	25	63	90	70
344025.0.DGP	BBT 40	25	63	35	74
344032.DGP	BBT 40	32	72	100	74
344032.0.DGP	BBT 40	32	72	65	80
344040.DGP	BBT 40	40	79	120	80

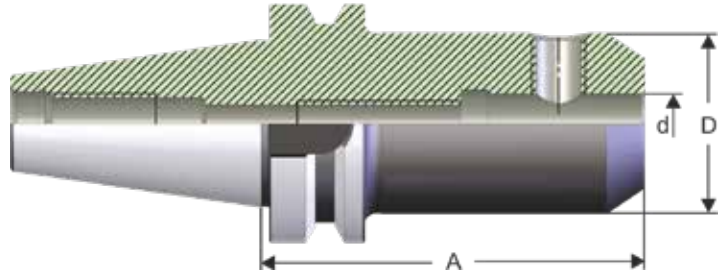

Sipariş Kodu Order Number	BBT	d h4	D	A	€
344106.DGP	BBT 40	6	25	100	71
344108.DGP	BBT 40	8	28	100	70
344110.DGP	BBT 40	10	35	100	70
344112.DGP	BBT 40	12	42	100	70
344114.DGP	BBT 40	14	44	100	70
344116.DGP	BBT 40	16	48	100	70
344118.DGP	BBT 40	18	50	100	70
344120.DGP	BBT 40	20	52	100	70

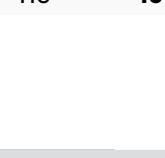
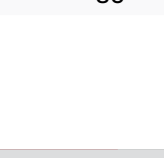
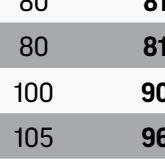
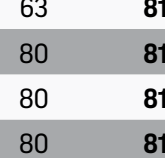
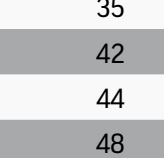
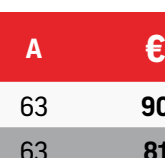
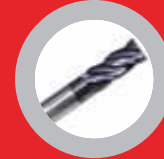
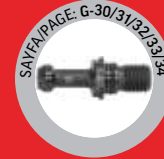
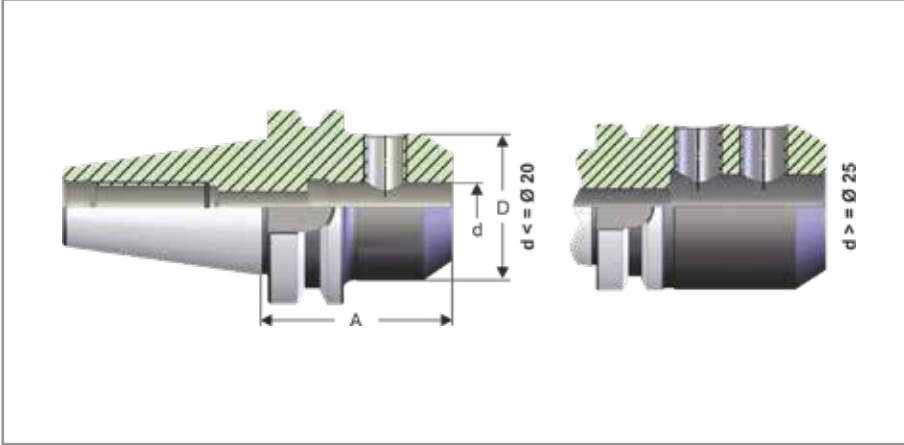

Sipariş Kodu Order Number	BBT	d h4	D	A	€
345006.DGP	BBT 50	6	25	63	90
345008.DGP	BBT 50	8	28	63	81
345010.DGP	BBT 50	10	35	63	81
345012.DGP	BBT 50	12	42	80	81
345014.DGP	BBT 50	14	44	80	81
345016.DGP	BBT 50	16	48	80	81
345018.DGP	BBT 50	18	50	80	81
345020.DGP	BBT 50	20	52	80	81
345025.DGP	BBT 50	25	65	100	90
345032.DGP	BBT 50	32	72	105	96
345040.DGP	BBT 50	40	80	110	101

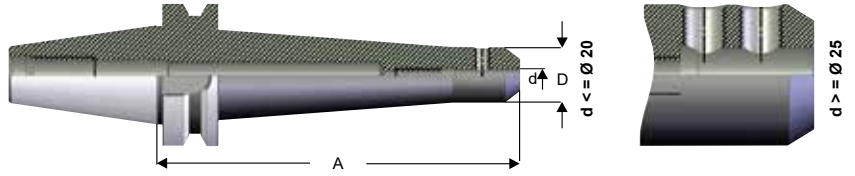

Sipariş Kodu
Order Number

BBT

d
h4

D

A

€

345106.DGP

BBT 50

6

25

160

138

345108.DGP

BBT 50

8

28

160

138

345110.DGP

BBT 50

10

35

160

138

345112.DGP

BBT 50

12

42

160

138

345114.DGP

BBT 50

14

44

160

138

345116.DGP

BBT 50

16

48

160

138

345118.DGP

BBT 50

18

50

160

138

345120.DGP

BBT 50

20

52

160

138

345125.DGP

BBT 50

25

65

160

144

345132.DGP

BBT 50

32

72

160

152

345140.DGP

BBT 50

40

80

160

158

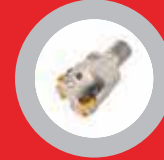
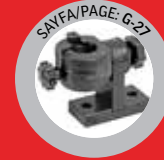
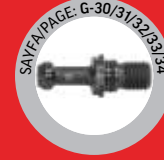
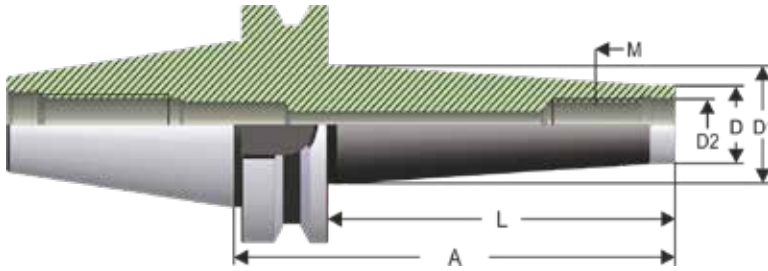

Sipariş Kodu Order Number	BBT	M	D	D1	A	L	D2	€
384006.DGP	BBT 40	M6	10	13	52	25	6,5	122
384006.1.DGP	BBT 40	M6	10	20	77	50	6,5	139
384006.2.DGP	BBT 40	M6	10	23	102	75	6,5	151
384008.DGP	BBT 40	M8	13	15	52	25	8,5	122
384008.1.DGP	BBT 40	M8	13	23	77	50	8,5	133
384008.2.DGP	BBT 40	M8	13	23	102	75	8,5	151
384008.3.DGP	BBT 40	M8	13	25	127	100	8,5	174
384010.DGP	BBT 40	M10	18	20	52	25	10,5	122
384010.1.DGP	BBT 40	M10	18	23	77	50	10,5	133
384010.2.DGP	BBT 40	M10	18	28	102	75	10,5	151
384010.3.DGP	BBT 40	M10	18	36,5	177	150	10,5	214
384012.DGP	BBT 40	M12	21	24	52	25	12,5	122
384012.1.DGP	BBT 40	M12	21	24	77	50	12,5	133
384012.2.DGP	BBT 40	M12	21	31	102	75	12,5	151
384012.3.DGP	BBT 40	M12	21	36	152	125	12,5	207
384012.4.DGP	BBT 40	M12	21	38	177	150	12,5	220
384016.DGP	BBT 40	M16	29	29	52	25	17	126
384016.1.DGP	BBT 40	M16	29	34	77	50	17	139
384016.2.DGP	BBT 40	M16	29	34	102	75	17	151
384016.3.DGP	BBT 40	M16	29	36	127	100	17	174
384016.4.DGP	BBT 40	M16	29	40	152	125	17	207
384016.5.DGP	BBT 40	M16	29	42,5	177	150	17	220

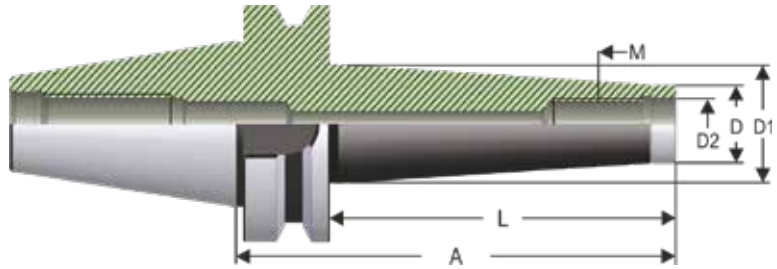
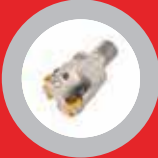

Sipariş Kodu Order Number	BBT	M	D	D1	A	L	D2	€
385008.DGP	BBT 50	M8	13	23	88	50	8,5	207
385008.1.DGP	BBT 50	M8	13	25	138	100	8,5	240
385008.2.DGP	BBT 50	M8	13	30	188	150	8,5	309
385010.DGP	BBT 50	M10	18	23	88	50	10,5	207
385010.1.DGP	BBT 50	M10	18	32	138	100	10,5	240
385010.2.DGP	BBT 50	M10	18	36,5	188	150	10,5	309
385012.DGP	BBT 50	M12	21	24	88	50	12,5	207
385012.1.DGP	BBT 50	M12	21	33	138	100	12,5	240
385012.2.DGP	BBT 50	M12	21	40	188	150	12,5	309
385016.DGP	BBT 50	M16	29	34	88	50	16,5	207
385016.1.DGP	BBT 50	M16	29	36	138	100	16,5	240
385016.2.DGP	BBT 50	M16	29	42,5	188	150	16,5	309

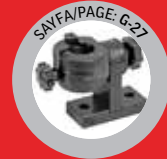

Sipariş Kodu Order Number	BBT	Pens Collet	Adet Piece	Ölçüler Contents	€
394430.DGP	BBT 40	430 / ER 25	14	3-4-5-6-7-8-9-10-11-12-14-16 - 9042430 - 311430.DGP	324
394470.DGP	BBT 40	470 / ER 32	16	3-4-5-6-7-8-9-10-11-12-14-16-18-20 - 9050470 - 311470.DGP	331
394472.DGP	BBT 40	472 / ER 40	18	4-5-6-7-8-9-10-11-12-14-16-18-20-22-24-26 - 9063472 - 311472.DGP	450
395470.DGP	BBT 50	470 / ER 32	16	3-4-5-6-7-8-9-10-11-12-14-16-18-20 - 9050470 - 315470.DGP	359
395472.DGP	BBT 50	472 / ER 40	18	4-5-6-7-8-9-10-11-12-14-16-18-20-22-24-26 - 9063472 - 315472.DGP	478
395467.DGP	BBT 50	467	18	5-6-7-8-10-12-14-16-18-20-22-24-25-28-30-32-906875 315467.DGP	633



Sipariş Kodu Order Number	BBT	Kapasite Capacity	Adet Piece	Ölçüler Contents	€
398420.DGP	BBT 40	6-20	7	6-8-10-12-16 - 904550 - 318420.DGP	581
398432.DGP	BBT 40	6-32	9	6-8-10-12-16-20-25 -906875 - 318432.DGP	743
399520.DGP	BBT 50	6-20	7	6-8-10-12-16 - 904550 - 319520.DGP	768
399532.DGP	BBT 50	6-32	9	6-8-10-12-16-20-25 -906875 - 319532.DGP	879

DIN 2080
ISO TUTUCULAR
ISO TOOLHOLDERS



ISO TOOL HOLDERS

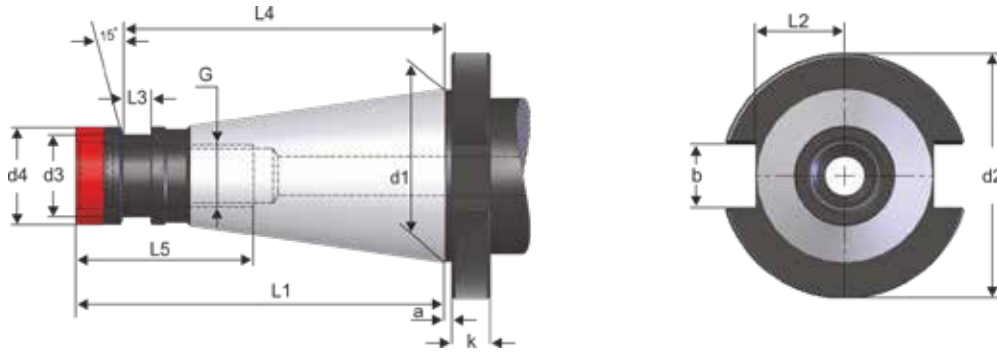

ISO	d1	a	b	k	G	d2	d3	d4	L1	L2	L3	L4	L5
ISO 30	31,75	1,6	16,1	8	M12	50	-	17,1	68,4	16,2	-	-	24
ISO 40	44,45	1,6	16,1	10	M16	63	21,1	25	93,4	22,5	7	82	32
ISO 50	69,85	3,2	25,7	12	M24	97,5	32	39,2	126,8	35,3	13,3	115	47

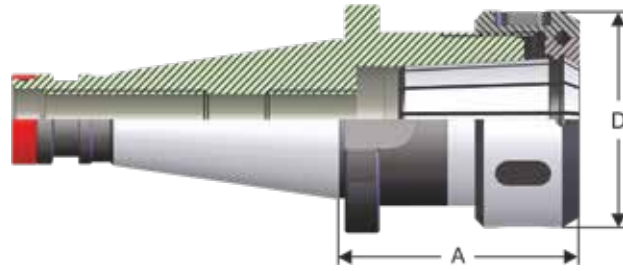

Sipariş Kodu Order Number	ISO	Kapasite Capacity	D	A	€
210415	ISO 30	415 (2-16)	43	50	64
210462	ISO 30	462 (2-25)	60	80	65
211415	ISO 40	415 (2-16)	43	55	64
211462	ISO 40	462 (2-25)	60	66	65
211467	ISO 40	467 (3-32)	72	95	76
215462	ISO 50	462 (2-25)	60	71	98
215467	ISO 50	467 (3-32)	72	73	101
215468	ISO 50	468 (3-40)	85	75	133

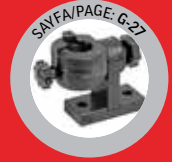
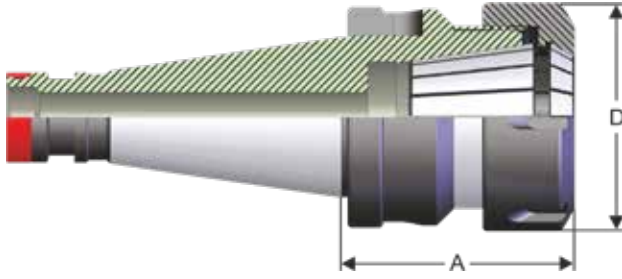

Sipariş Kodu Order Number	ISO	Kapasite Capacity	D	A	€
210430	ISO 30	ER 25 (2-16)	42	50	49
210470	ISO 30	ER 32 (2-20)	50	50	50
210472	ISO 30	ER 40 (2-26)	63	65	54
211430	ISO 40	ER 25 (2-16)	42	50	49
211470	ISO 40	ER 32 (2-20)	50	50	50
211472	ISO 40	ER 40 (2-26)	63	80	54
215470	ISO 50	ER 32 (2-20)	50	63	67
215472	ISO 50	ER 40 (2-26)	63	63	76

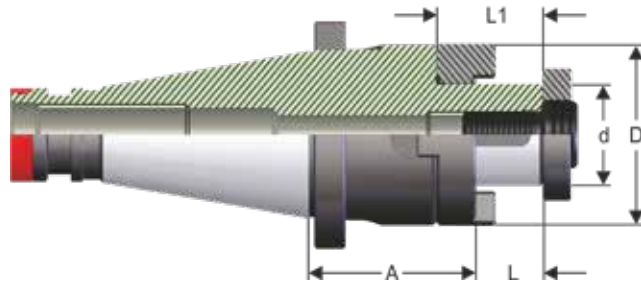
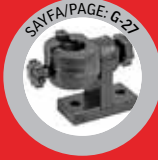

Sipariş Kodu Order Number	ISO	d h6	D	A	L	L1	€
223016	ISO 30	16	32	35	17	27	46
223022	ISO 30	22	40	35	19	31	46
223027	ISO 30	27	48	35	21	33	46
223032	ISO 30	32	58	50	24	38	50
224016	ISO 40	16	32	52	17	27	46
224022	ISO 40	22	40	52	19	31	46
224027	ISO 40	27	48	52	21	33	46
224032	ISO 40	32	58	52	24	38	50
224040	ISO 40	40	70	52	27	41	56
225016	ISO 50	16	32	55	17	27	66
225022	ISO 50	22	40	55	19	31	66
225027	ISO 50	27	48	55	21	33	67
225032	ISO 50	32	58	55	24	38	73
225040	ISO 50	40	70	55	27	41	81

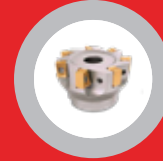
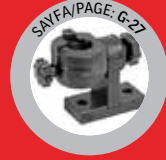
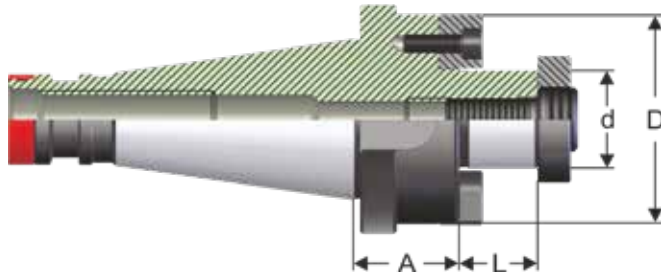

Sipariş Kodu Order Number	ISO	d h6	D	A	L	€
234016	ISO 40	16	38	30	17	49
234022	ISO 40	22	48	30	19	49
234027	ISO 40	27	58	30	21	49
234032	ISO 40	32	78	30	24	52
234040	ISO 40	40	88	30	27	60
235016	ISO 50	16	38	35	17	77
235022	ISO 50	22	48	35	19	77
235027	ISO 50	27	58	35	21	77
235032	ISO 50	32	78	40	24	81
235040	ISO 50	40	88	40	27	81
235060	ISO 50	60	128	55	40	165

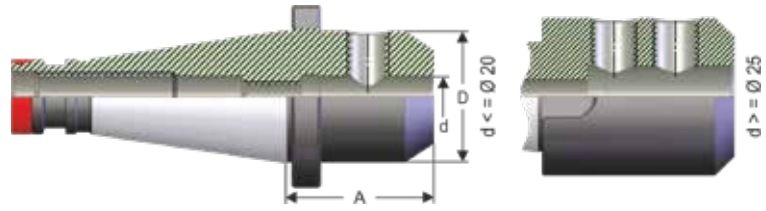

Sipariş Kodu Order Number	ISO	d h4	D	A	€
244006	ISO 40	6	25	50	38
244008	ISO 40	8	28	50	36
244010	ISO 40	10	35	50	36
244012	ISO 40	12	42	50	36
244014	ISO 40	14	44	50	36
244016	ISO 40	16	48	63	36
244018	ISO 40	18	50	63	36
244020	ISO 40	20	52	63	36
244025	ISO 40	25	63	80	46
244032	ISO 40	32	72	80	49
244040	ISO 40	40	79	90	54

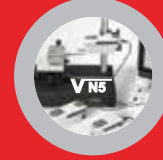
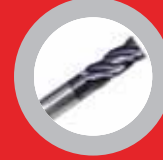
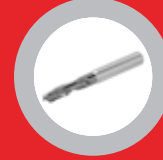
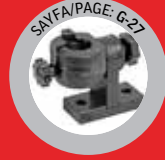
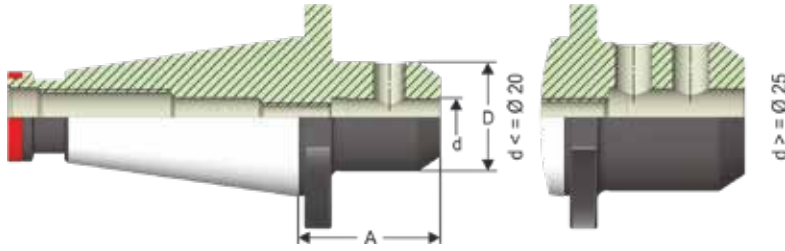

Sipariş Kodu Order Number	ISO	d h4	D	A	€
245006	ISO 50	6	25	63	62
245008	ISO 50	8	28	63	55
245010	ISO 50	10	35	63	52
245012	ISO 50	12	42	63	52
245014	ISO 50	14	44	63	52
245016	ISO 50	16	48	63	52
245018	ISO 50	18	50	63	52
245020	ISO 50	20	52	63	52
245025	ISO 50	25	65	80	57
245032	ISO 50	32	72	80	64
245040	ISO 50	40	80	90	73

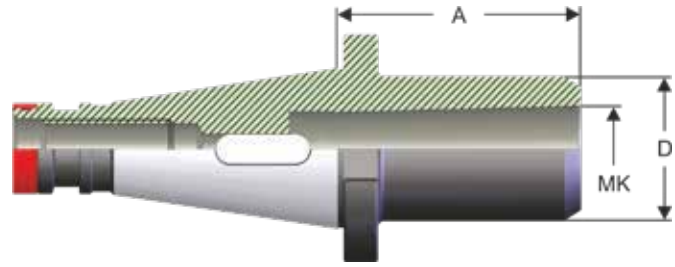
DIN 2080**KAMALI MORS ADAPTÖRÜ DIN 6383****MORSE TAPER ADTOR TANG DIN 6383****DEĞERLİ®**
www.degerlimakina.com

Sipariş Kodu Order Number	ISO	Mk Morse	A	D	€
253001	ISO 30	1	50	25	40
253002	ISO 30	2	50	32	40
253003	ISO 30	3	75	40	40
254001	ISO 40	1	50	25	40
254002	ISO 40	2	50	32	40
254003	ISO 40	3	65	40	40
254004	ISO 40	4	95	48	44
255001	ISO 50	1	45	25	63
255002	ISO 50	2	60	32	56
255003	ISO 50	3	65	40	63
255004	ISO 50	4	70	48	59
255005	ISO 50	5	105	63	66

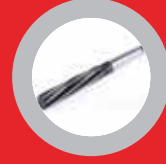
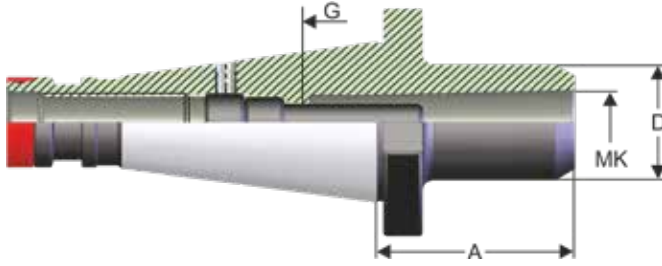

Sipariş Kodu Order Number	ISO	Mk Morse	A	D	G	€
264001	ISO 40	1	50	25	M6	51
264002	ISO 40	2	50	32	M10	51
264003	ISO 40	3	65	40	M12	51
264004	ISO 40	4	95	48	M16	58
265001	ISO 50	1	60	25	M6	76
265002	ISO 50	2	60	32	M10	76
265003	ISO 50	3	65	40	M12	76
265004	ISO 50	4	65	48	M16	87
265005	ISO 50	5	120	63	M20	101

DIN 2080**MANDREN BAŞLIĞI DIN 238**

DRILL CHUCK ADAPTOR DIN 238

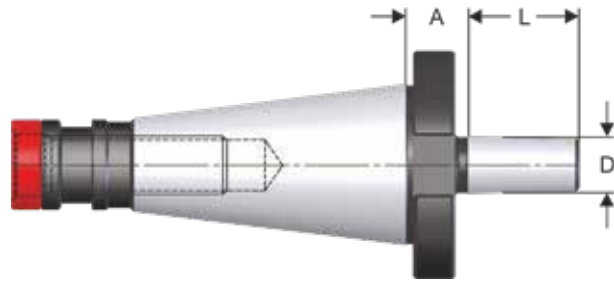
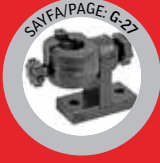
DEĞERLİ
www.degerlimakina.com

Sipariş Kodu Order Number	ISO	D	A	L	€
273012	ISO 30	B12	13,5	18,5	41
273016	ISO 30	B16	15,5	24	41
274012	ISO 40	B12	15	18,5	39
274016	ISO 40	B16	17	24	39
274018	ISO 40	B18	17	32	39
275016	ISO 50	B16	20	24	57
275018	ISO 50	B18	20	32	57

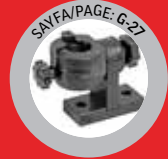
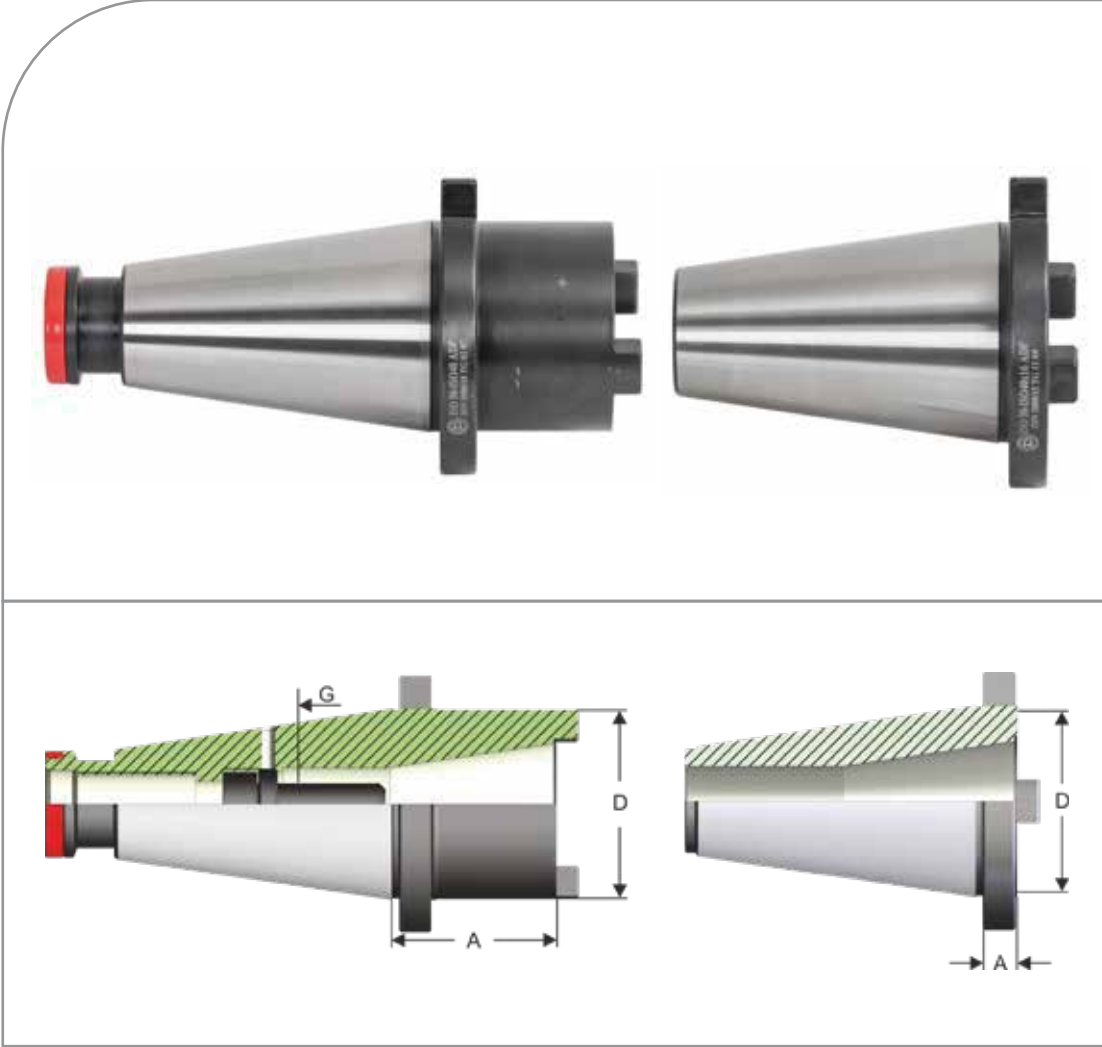

Sipariş Kodu Order Number	ISO	D	A	G	€
285040	ISO 50 / ISO 40	60	70	M16	115
285040.1	ISO 50 / ISO 40	16	70	-	122



SAYFA/PAGE: G-27



SAYFA/PAGE: G-26



SAYFA/PAGE: E-03



SAYFA/PAGE: G-07/09/10



SAYFA/PAGE: G-18



Sipariş Kodu Order Number	ISO	Pens Collet	Adet Piece	Ölçüler Contents	€
293415	ISO 30	415	16	3-4-5-6-7-8-9-10-11-12-13-14-15-16 - 904042 - 210415	301
293462	ISO 30	462	18	4-5-6-7-8-9-10-11-12-14-16-18-20-22-24-25 - 905862 - 210462	405
294415	ISO 40	415	16	3-4-5-6-7-8-9-10-11-12-13-14-15-16 - 904042 - 211415	301
294462	ISO 40	462	18	4-5-6-7-8-9-10-11-12-14-16-18-20-22-24-25 - 905862 - 211462	405
294467	ISO 40	467	18	5-6-7-8-10-12-14-16-18-20-22-24-25-28-30-32 - 906875 - 211467	566
295462	ISO 50	462	18	4-5-6-7-8-9-10-11-12-14-16-18-20-22-24-25 - 905862 - 215462	438
295467	ISO 50	467	18	5-6-7-8-10-12-14-16-18-20-22-24-25-28-30-32 - 906875 - 215467	591
295468	ISO 50	468	22	6-7-8-9-10-12-14-16-18-20-22-24-25-28-30-32-34-36-38-40 - 908090 - 215468	983



Sipariş Kodu Order Number	ISO	Pens Collet	Adet Piece	Ölçüler Contents,	€
293430	ISO 30	430 / ER 25	14	3-4-5-6-7-8-9-10-11-12-14-16 - 9042430 - 210430	299
293470	ISO 30	470 / ER 32	16	3-4-5-6-7-8-9-10-11-12-14-16-18-20 - 9050470 - 210470	305
293472	ISO 30	472 / ER 40	18	4-5-6-7-8-9-10-11-12-14-16-18-20-22-24-26 - 9063472 - 210472	424
294430	ISO 40	430 / ER 25	14	3-4-5-6-7-8-9-10-11-12-14-16 - 9042430 - 211430	299
294470	ISO 40	470 / ER 32	16	3-4-5-6-7-8-9-10-11-12-14-16-18-20 - 9050470 - 211470	305
294472	ISO 40	472 / ER 40	18	4-5-6-7-8-9-10-11-12-14-16-18-20-22-24-26 - 9063472 - 211472	424
295470	ISO 50	470 / ER 32	16	3-4-5-6-7-8-9-10-11-12-14-16-18-20 - 9050470 - 215470	322
295472	ISO 50	472 / ER 40	18	4-5-6-7-8-9-10-11-12-14-16-18-20-22-24-26 - 9063472 - 215472	446



**SİLİNDİRİK ŞAFTLI
TUTUCULAR**
CYLINDRICAL SHAFT
TOOLHOLDERS

**CYLINDRICAL
SHAFT TOOLHOLDERS**

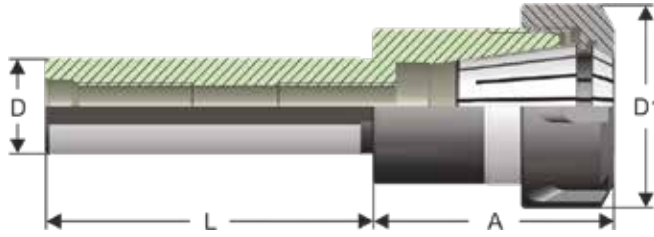

Sipariş Kodu Order Number	Ø	Kapasite Capacity	D	L	A	D1	€
416426.3	16	ER 16 MİNi (2-10)	16	150	35	22	78
420426	20	ER 16 (2-10)	20	70	30	32	59
420426.1	20	ER 16 (2-10)	20	100	30	32	65
420426.2	20	ER 16 MİNi (2-10)	20	100	30	22	78
420426.3	20	ER 16 MİNi (2-10)	20	150	30	22	81
420426.4	20	ER 16 (2-10)	20	150	30	32	56
420426.5	20	ER 16 MİNi (2-10)	20	200	30	22	121
420428	20	ER 20 (2-13)	20	70	45	34	65
420428.1	20	ER 20 (2-13)	20	100	45	34	72
420428.2	20	ER 20 (2-13)	20	150	45	34	78
420430	20	ER 25 (2-16)	20	70	52	42	52
420430.1	20	ER 25 (2-16)	20	150	52	42	55
420470	20	ER 32 (2-20)	20	70	55	50	52
420470.1	20	ER 32 (2-20)	20	150	55	50	56

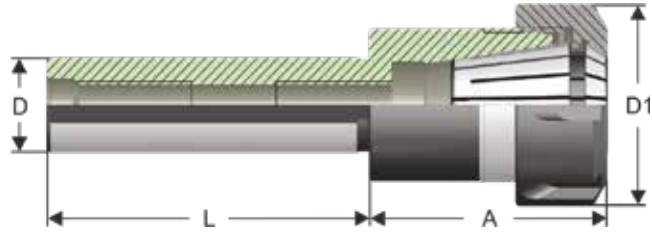

Sipariş Kodu Order Number	Ø	Kapasite Capacity	D	L	A	D1	€
425426	25	ER 16 (2-10)	25	70	32	32	59
425426.1	25	ER 16 (2-10)	25	150	32	32	72
425428	25	ER 20 (2-13)	25	70	35	34	59
425428.1	25	ER 20 (2-13)	25	150	35	34	72
425430	25	ER 25 (2-16)	25	70	50	42	52
425430.1	25	ER 25 (2-16)	25	150	50	42	56
425470	25	ER 32 (2-20)	25	70	55	50	52
425470.1	25	ER 32 (2-20)	25	150	55	50	57

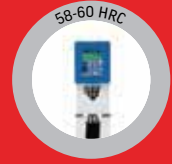
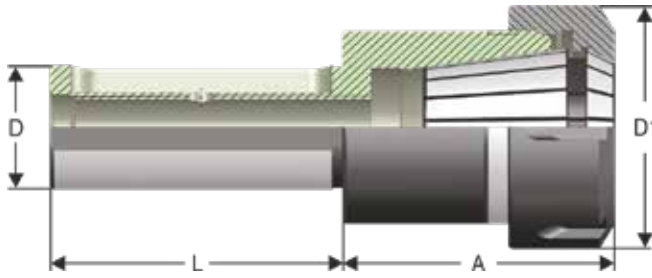

Sipariş Kodu Order Number	Ø	Kapasite Capacity	D	L	A	D1	€
432426	32	ER 16 (2-10)	32	80	32	32	59
432430	32	ER 25 (2-16)	32	80	32	42	52
432430.1	32	ER 25 (2-16)	32	150	32	42	59
432470	32	ER 32 (2-20)	32	80	52	50	55
432470.1	32	ER 32 (2-20)	32	150	52	50	60
432472	32	ER 40 (2-26)	32	80	63	63	65
432472.1	32	ER 40 (2-26)	32	150	63	63	70

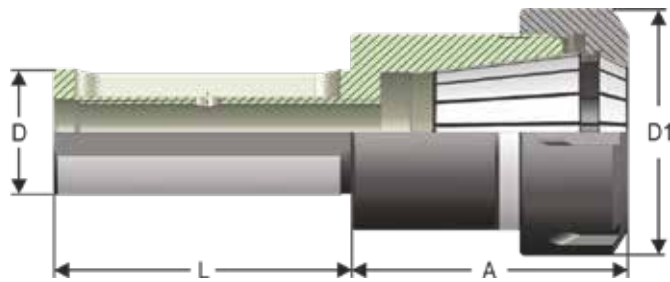

Sipariş Kodu Order Number	Ø	Kapasite Capacity	D	L	A	D1	€
440430	40	ER 25 (2-16)	40	85	32	42	62
440430.1	40	ER 25 (2-16)	40	150	32	42	70
440470	40	ER 32 (2-20)	40	85	35	50	65
440470.1	40	ER 32 (2-20)	40	150	35	50	70
440472	40	ER 40 (2-26)	40	85	45	63	72
440472.1	40	ER 40 (2-26)	40	150	45	63	78

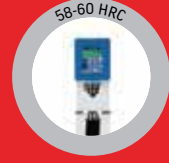
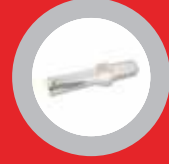
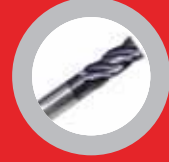
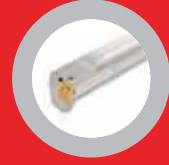
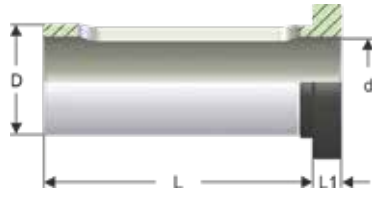

Sipariş Kodu Order Number	Ø	d	D	L	L1	€
42006	20	6	20	40	5	43
42008	20	8	20	40	5	43
42010	20	10	20	40	5	43
42012	20	12	20	40	5	43
42014	20	14	20	40	5	43
42016	20	16	20	40	5	43

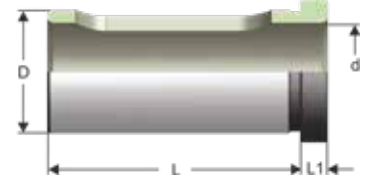
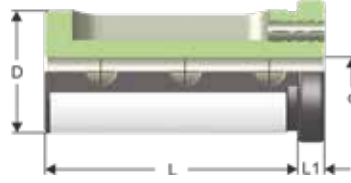
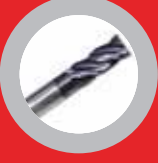
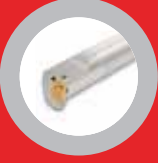

Sipariş Kodu Order Number	Ø	d	D	L	L1	€
42506	25	6	25	45	5	38
42508	25	8	25	45	5	38
42510	25	10	25	45	5	38
42512	25	12	25	45	5	38
42514	25	14	25	45	5	38
42516	25	16	25	45	5	38
42520	25	20	25	45	5	38

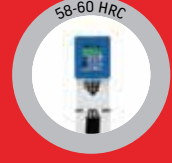
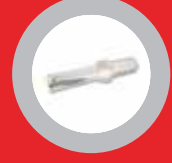
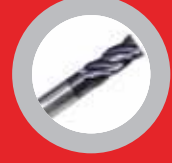
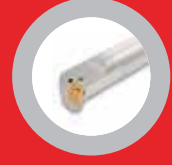
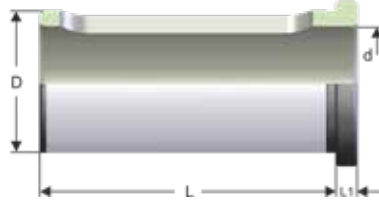
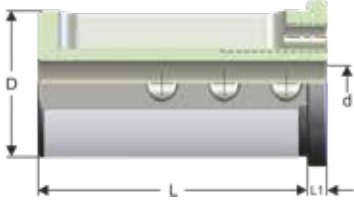

Sipariş Kodu Order Number	Ø	d	D	L	L1	€
43206	32	6	32	65	5	39
43208	32	8	32	65	5	39
43210	32	10	32	65	5	39
43212	32	12	32	65	5	39
43214	32	14	32	65	5	39
43216	32	16	32	65	5	39
43220	32	20	32	65	5	39
43225	32	25	32	65	5	39

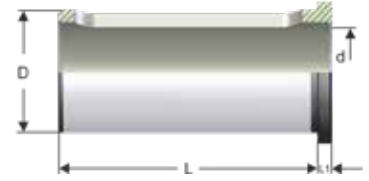
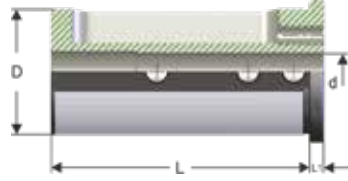
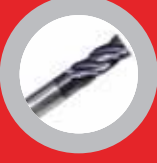
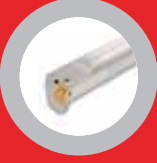

Sipariş Kodu Order Number	Ø	d	D	L	L1	€
44006	40	6	40	75	5	42
44008	40	8	40	75	5	42
44010	40	10	40	75	5	42
44012	40	12	40	75	5	42
44014	40	14	40	75	5	42
44016	40	16	40	75	5	42
44020	40	20	40	75	5	42
44025	40	25	40	75	5	42
44032	40	32	40	75	5	42

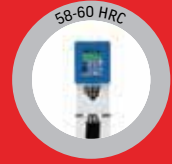
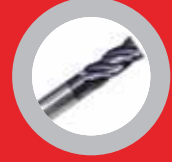
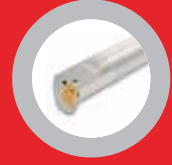
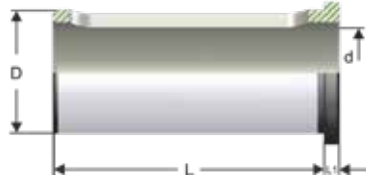
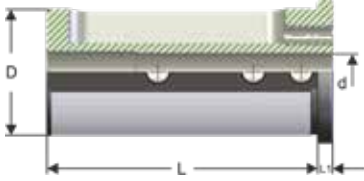

58-60 HRC

Sipariş Kodu Order Number	Ø	d	D	L	L1	€
45006	50	6	50	90	5	55
45008	50	8	50	90	5	55
45010	50	10	50	90	5	55
45012	50	12	50	90	5	55
45014	50	14	50	90	5	55
45016	50	16	50	90	5	55
45020	50	20	50	90	5	55
45025	50	25	50	90	5	55
45032	50	32	50	90	5	55
45040	50	40	50	90	5	55

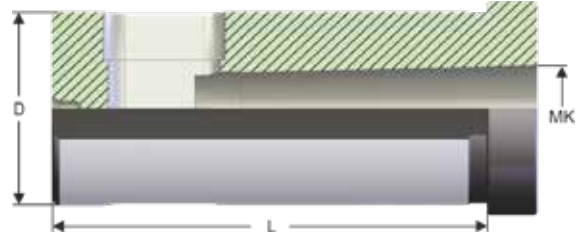

Sipariş Kodu Order Number	Ø	Mk Morse	D	L	€
42501	25	1	25	70	46
42502	25	2	25	75	46
43201	32	1	32	75	46
43202	32	2	32	80	46
43203	32	3	32	80	46
44001	40	1	40	75	48
44002	40	2	40	85	48
44003	40	3	40	85	48
44004	40	4	40	85	48
45001	50	1	50	75	62
45002	50	2	50	88	62
45003	50	3	50	90	62
45004	50	4	50	90	62

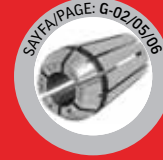
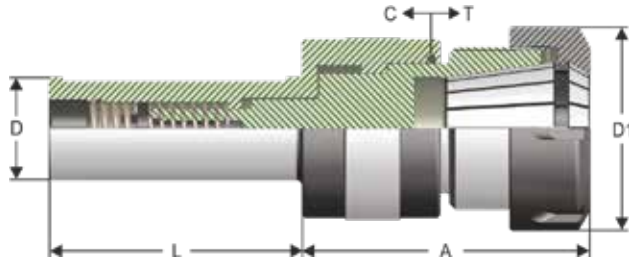

Sipariş Kodu Order Number	Ø	Kapasite Capacity	D	L	A	D1	C	T	€
4820426	20	ER 16 (2-10)	20	80	42	32	8	3	154
4825426	25	ER 16 (2-10)	25	80	42	32	8	3	171
4832470	32	ER 32 (2-20)	32	80	77	50	9	4	183
4832472	32	ER 40 (2-26)	32	80	96	63	9	4	197

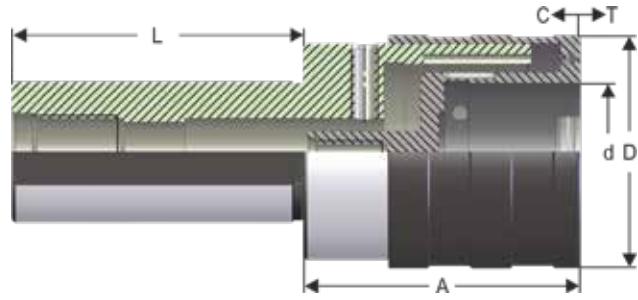

Sipariş Kodu Order Number	Ø	Kapasite Capacity	A	D	d	C	T	L	€
4825214	25	M2-M14	45	38	19	7	7	70	177
4825524	25	M5-M24	71	54	31	12	12	70	204
4832214	32	M2-M14	45	38	19	7	7	80	177
4832524	32	M5-M24	71	54	31	12	12	80	204
4840214	40	M2-M14	45	38	19	7	7	85	205
4840524	40	M5-M24	71	54	31	12	12	85	216
4850524	50	M5-M24	71	54	31	12	12	100	246



Sipariş Kodu Order Number	Ø	Pens Collet	Adet Piece	Ölçüler Contents	€
4920430	20	ER 25 / 430	14	3-4-5-6-7-8-9-10-11-12-14-16 - 9042430 - 420430	302
4920470	20	ER 32 / 470	16	3-4-5-6-7-8-9-10-11-12-14-16-18-20 - 9050470 - 420470	307
4925430	25	ER 25 / 430	14	3-4-5-6-7-8-9-10-11-12-14-16 - 9042430 - 425430	302
4925470	25	ER 32 / 470	16	3-4-5-6-7-8-9-10-11-12-14-16-18-20 - 9050470 - 425470	307
4932430	32	ER 25 / 430	14	3-4-5-6-7-8-9-10-11-12-14-16 - 9042430 - 432430	302
4932470	32	ER 32 / 470	16	3-4-5-6-7-8-9-10-11-12-14-16-18-20 - 9050470 - 432470	310
4932472	32	ER 40 / 472	18	4-5-6-7-8-9-10-11-12-14-16-18-20-22-24-26 - 9063472 - 432472	435
4940430	40	ER 25 / 430	14	3-4-5-6-7-8-9-10-11-12-14-16 - 9042430 - 440430	312
4940470	40	ER 32 / 470	16	3-4-5-6-7-8-9-10-11-12-14-16-18-20 - 9050470 - 440470	320
4940472	40	ER 40 / 472	18	4-5-6-7-8-9-10-11-12-14-16-18-20-22-24-26 - 9063472 - 440472	442

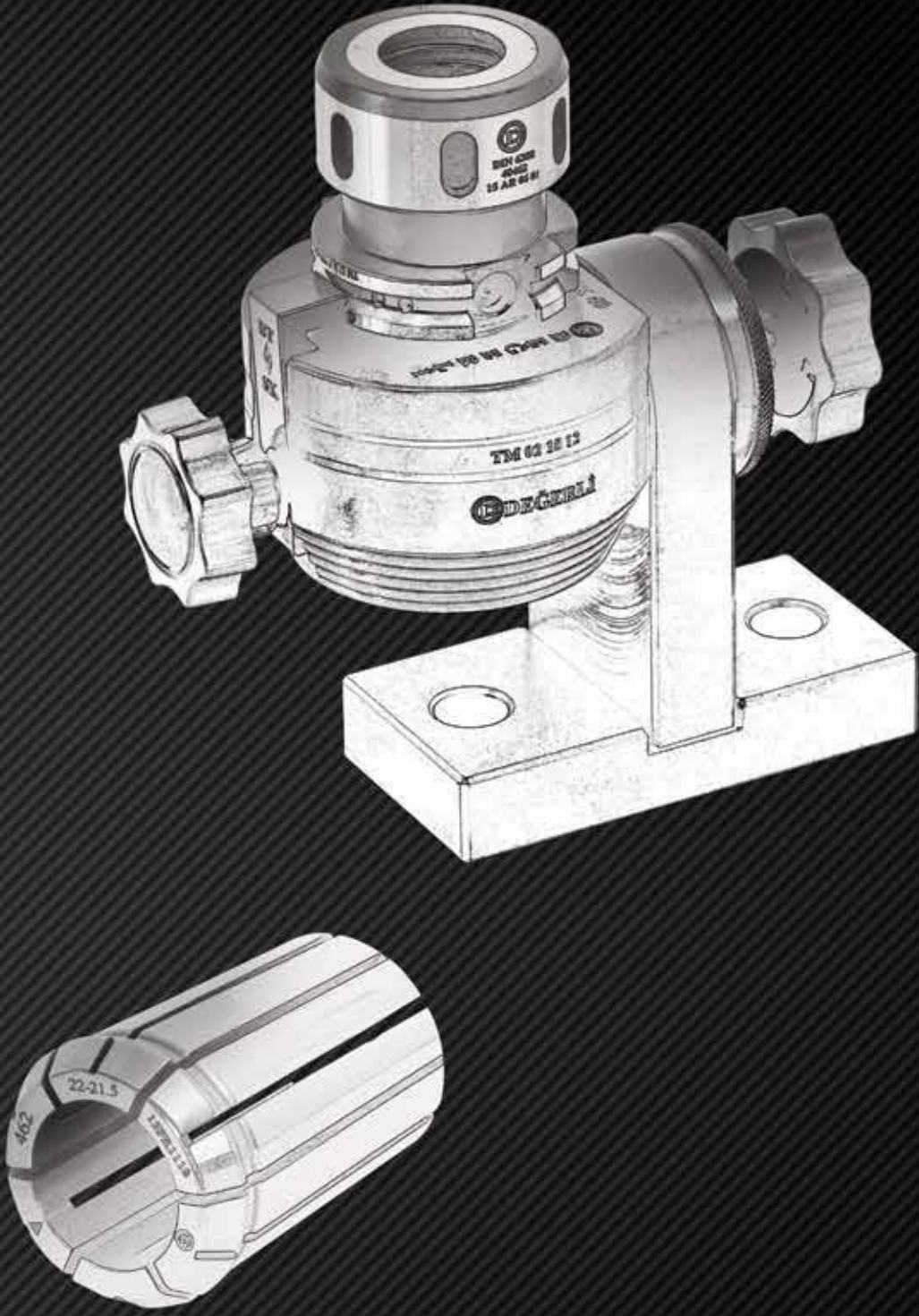

PENSLER VE DİĞER ÜRÜNLER
COLLETS AND OTHER PRODUCTS

COLLETS AND OTHER PRODUCTS

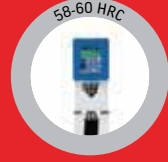
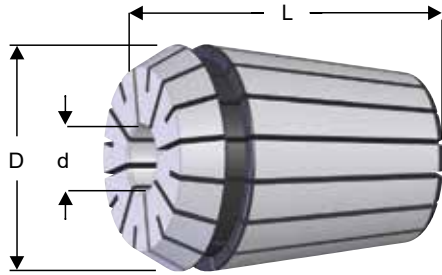

Sipariş Kodu Order Number	Pens Collet	Kapasite Capacity (d)	D	L	€
100426.03	ER 16 - 426	3 - 2 mm	17	27,5	13
100426.04	ER 16 - 426	4 - 3 mm	17	27,5	13
100426.05	ER 16 - 426	5 - 4 mm	17	27,5	13
100426.06	ER 16 - 426	6 - 5 mm	17	27,5	13
100426.07	ER 16 - 426	7 - 6 mm	17	27,5	13
100426.08	ER 16 - 426	8 - 7 mm	17	27,5	13
100426.09	ER 16 - 426	9 - 8 mm	17	27,5	13
100426.10	ER 16 - 426	10 - 9 mm	17	27,5	13

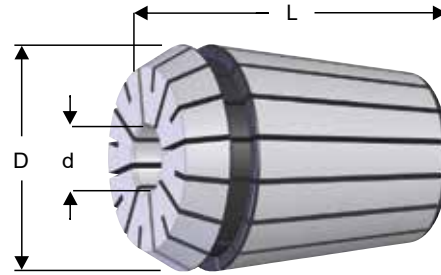

Sipariş Kodu Order Number	Pens Collet	Kapasite Capacity (d)	D	L	€
100428.03	ER 20 - 428	3 - 2 mm	21	31,5	14
100428.04	ER 20 - 428	4 - 3 mm	21	31,5	14
100428.05	ER 20 - 428	5 - 4 mm	21	31,5	14
100428.06	ER 20 - 428	6 - 5 mm	21	31,5	14
100428.07	ER 20 - 428	7 - 6 mm	21	31,5	14
100428.08	ER 20 - 428	8 - 7 mm	21	31,5	14
100428.09	ER 20 - 428	9 - 8 mm	21	31,5	14
100428.10	ER 20 - 428	10 - 9 mm	21	31,5	14
100428.11	ER 20 - 428	11 - 10 mm	21	31,5	14
100428.12	ER 20 - 428	12 - 11 mm	21	31,5	14
100428.13	ER 20 - 428	13 - 12 mm	21	31,5	14

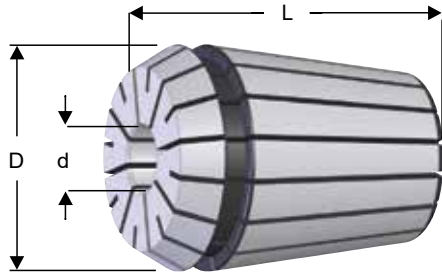

Sipariş Kodu Order Number	Pens Collet	Kapasite Capacity (d)	D	L	€
100430.03	ER 25 - 430	3 - 2 mm	26	34	15
100430.04	ER 25 - 430	4 - 3 mm	26	34	15
100430.05	ER 25 - 430	5 - 4 mm	26	34	15
100430.06	ER 25 - 430	6 - 5 mm	26	34	15
100430.07	ER 25 - 430	7 - 6 mm	26	34	15
100430.08	ER 25 - 430	8 - 7 mm	26	34	15
100430.09	ER 25 - 430	9 - 8 mm	26	34	15
100430.10	ER 25 - 430	10 - 9 mm	26	34	15
100430.11	ER 25 - 430	11 - 10 mm	26	34	15
100430.12	ER 25 - 430	12 - 11 mm	26	34	15
100430.13	ER 25 - 430	13 - 12 mm	26	34	15
100430.14	ER 25 - 430	14 - 13 mm	26	34	15
100430.15	ER 25 - 430	15 - 14 mm	26	34	15
100430.16	ER 25 - 430	16 - 15 mm	26	34	15



SAYFA/PAGE: G-19



SAYFA/PAGE: G-29



SAYFA/PAGE: G-14/15



SAYFA/PAGE: C-29/D-16



SAYFA/PAGE: B-28



SAYFA/PAGE: E-14



SAYFA/PAGE: A-28



58-60 HRC

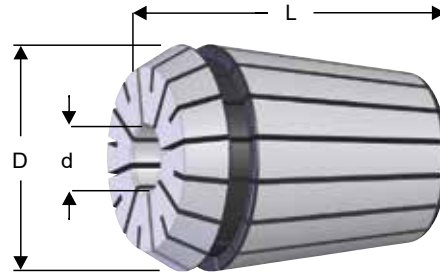

Sipariş Kodu Order Number	Pens Collet	Kapasite Capacity (d)	D	L	€
100470.03	ER 32 - 470	3 - 2 mm	33	40	15
100470.04	ER 32 - 470	4 - 3 mm	33	40	15
100470.05	ER 32 - 470	5 - 4 mm	33	40	15
100470.06	ER 32 - 470	6 - 5 mm	33	40	15
100470.07	ER 32 - 470	7 - 6 mm	33	40	15
100470.08	ER 32 - 470	8 - 7 mm	33	40	15
100470.09	ER 32 - 470	9 - 8 mm	33	40	15
100470.10	ER 32 - 470	10 - 9 mm	33	40	15
100470.11	ER 32 - 470	11 - 10 mm	33	40	15
100470.12	ER 32 - 470	12 - 11 mm	33	40	15
100470.13	ER 32 - 470	13 - 12 mm	33	40	15
100470.14	ER 32 - 470	14 - 13 mm	33	40	15
100470.15	ER 32 - 470	15 - 14 mm	33	40	15
100470.16	ER 32 - 470	16 - 15 mm	33	40	15
100470.17	ER 32 - 470	17 - 16 mm	33	40	15
100470.18	ER 32 - 470	18 - 17 mm	33	40	15
100470.19	ER 32 - 470	19 - 18 mm	33	40	15
100470.20	ER 32 - 470	20 - 19 mm	33	40	15

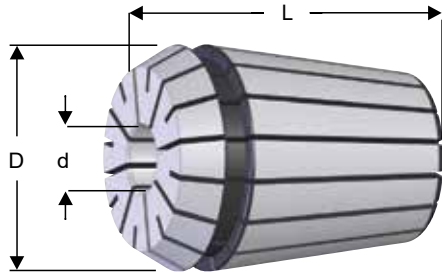

Sipariş Kodu Order Number	Pens Collet	Kapasite Capacity (d)	D	L	€
100472.03	ER 40 - 472	3 - 2 mm	41	46	26
100472.04	ER 40 - 472	4 - 3 mm	41	46	20
100472.05	ER 40 - 472	5 - 4 mm	41	46	20
100472.06	ER 40 - 472	6 - 5 mm	41	46	20
100472.07	ER 40 - 472	7 - 6 mm	41	46	20
100472.08	ER 40 - 472	8 - 7 mm	41	46	20
100472.09	ER 40 - 472	9 - 8 mm	41	46	20
100472.10	ER 40 - 472	10 - 9 mm	41	46	20
100472.11	ER 40 - 472	11 - 10 mm	41	46	20
100472.12	ER 40 - 472	12 - 11 mm	41	46	20
100472.13	ER 40 - 472	13 - 12 mm	41	46	20
100472.14	ER 40 - 472	14 - 13 mm	41	46	20
100472.15	ER 40 - 472	15 - 14 mm	41	46	20
100472.16	ER 40 - 472	16 - 15 mm	41	46	20
100472.17	ER 40 - 472	17 - 16 mm	41	46	20
100472.18	ER 40 - 472	18 - 17 mm	41	46	20
100472.19	ER 40 - 472	19 - 18 mm	41	46	20
100472.20	ER 40 - 472	20 - 19 mm	41	46	20
100472.21	ER 40 - 472	21 - 20 mm	41	46	20
100472.22	ER 40 - 472	22 - 21 mm	41	46	20
100472.23	ER 40 - 472	23 - 22 mm	41	46	20
100472.24	ER 40 - 472	24 - 23 mm	41	46	20
100472.25	ER 40 - 472	25 - 24 mm	41	46	20
100472.26	ER 40 - 472	26 - 25 mm	41	46	20

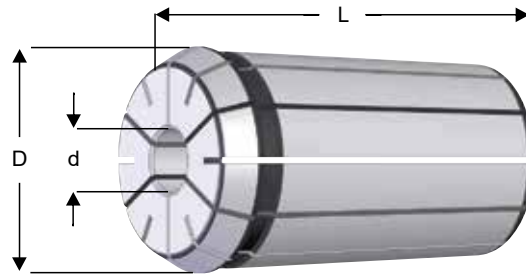

Sipariş Kodu Order Number	Pens Collet	Kapasite Capacity (d)	D	L	€
100415.03	415	3 - 2,5 mm	25,5	40	17
100415.04	415	4 - 3,5 mm	25,5	40	17
100415.05	415	5 - 4,5 mm	25,5	40	17
100415.06	415	6 - 5,5 mm	25,5	40	17
100415.07	415	7 - 6,5 mm	25,5	40	17
100415.08	415	8 - 7,5 mm	25,5	40	17
100415.09	415	9 - 8,5 mm	25,5	40	17
100415.10	415	10 - 9,5 mm	25,5	40	17
100415.11	415	11 - 10,5 mm	25,5	40	17
100415.12	415	12 - 11,5 mm	25,5	40	17
100415.13	415	13 - 12,5 mm	25,5	40	17
100415.14	415	14 - 13,5 mm	25,5	40	17
100415.15	415	15 - 14,5 mm	25,5	40	17
100415.16	415	16 - 15,5 mm	25,5	40	17

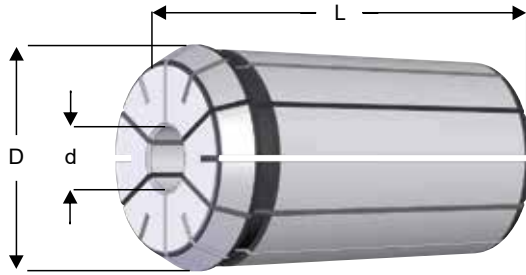

Sipariş Kodu Order Number	Pens Collet	Kapasite Capacity (d)	D	L	€
100462.03	462	3 - 2,5 mm	35,05	52	19
100462.04	462	4 - 3,5 mm	35,05	52	19
100462.05	462	5 - 4,5 mm	35,05	52	19
100462.06	462	6 - 5,5 mm	35,05	52	19
100462.07	462	7 - 6,5 mm	35,05	52	19
100462.08	462	8 - 7,5 mm	35,05	52	19
100462.09	462	9 - 8,5 mm	35,05	52	19
100462.10	462	10 - 9,5 mm	35,05	52	19
100462.11	462	11 - 10,5 mm	35,05	52	19
100462.12	462	12 - 11,5 mm	35,05	52	19
100462.13	462	13 - 12,5 mm	35,05	52	19
100462.14	462	14 - 13,5 mm	35,05	52	19
100462.15	462	15 - 14,5 mm	35,05	52	19
100462.16	462	16 - 15,5 mm	35,05	52	19
100462.17	462	17 - 16,5 mm	35,05	52	19
100462.18	462	18 - 17,5 mm	35,05	52	19
100462.19	462	19 - 18,5 mm	35,05	52	19
100462.20	462	20 - 19,5 mm	35,05	52	19
100462.21	462	21 - 20,5 mm	35,05	52	19
100462.22	462	22 - 21,5 mm	35,05	52	19
100462.23	462	23 - 22,5 mm	35,05	52	19
100462.24	462	24 - 23,5 mm	35,05	52	19
100462.25	462	25 - 24,5 mm	35,05	52	19

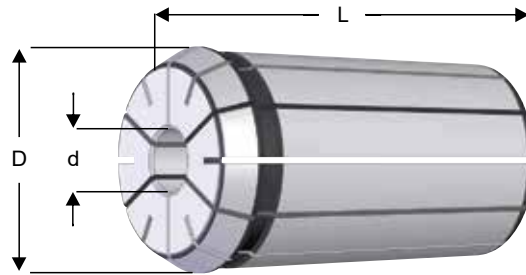

Sipariş Kodu Order Number	Pens Collet	Kapasite Capacity (d)	D	L	€
100467.03	467	3 - 2,5 mm	43,7	60	39
100467.04	467	4 - 3,5 mm	43,7	60	39
100467.05	467	5 - 4,5 mm	43,7	60	28
100467.06	467	6 - 5,5 mm	43,7	60	28
100467.07	467	7 - 6,5 mm	43,7	60	28
100467.08	467	8 - 7,5 mm	43,7	60	28
100467.09	467	9 - 8,5 mm	43,7	60	28
100467.10	467	10 - 9,5 mm	43,7	60	28
100467.11	467	11 - 10,5 mm	43,7	60	28
100467.12	467	12 - 11,5 mm	43,7	60	28
100467.13	467	13 - 12,5 mm	43,7	60	28
100467.14	467	14 - 13,5 mm	43,7	60	28
100467.15	467	15 - 14,5 mm	43,7	60	28
100467.16	467	16 - 15,5 mm	43,7	60	28
100467.17	467	17 - 16,5 mm	43,7	60	28

Sipariş Kodu Order Number	Pens Collet	Kapasite Capacity (d)	D	L	€
100467.18	467	18 - 17,5 mm	43,7	60	28
100467.19	467	19 - 18,5 mm	43,7	60	28
100467.20	467	20 - 19,5 mm	43,7	60	28
100467.21	467	21 - 20,5 mm	43,7	60	28
100467.22	467	22 - 21,5 mm	43,7	60	28
100467.23	467	23 - 22,5 mm	43,7	60	28
100467.24	467	24 - 23,5 mm	43,7	60	28
100467.25	467	25 - 24,5 mm	43,7	60	28
100467.26	467	26 - 25,5 mm	43,7	60	28
100467.27	467	27 - 26,5 mm	43,7	60	28
100467.28	467	28 - 27,5 mm	43,7	60	28
100467.29	467	29 - 28,5 mm	43,7	60	28
100467.30	467	30 - 29,5 mm	43,7	60	28
100467.31	467	31 - 30,5 mm	43,7	60	28
100467.32	467	32 - 31,5 mm	43,7	60	28

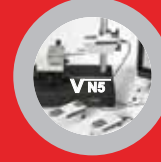
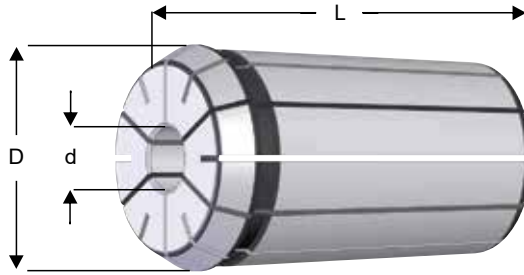

Sipariş Kodu Order Number	Pens Collet	Kapasite Capacity (d)	D	L	€
100468.04	468	4 - 3,5 mm	52,2	68	60
100468.05	468	5 - 4,5 mm	52,2	68	60
100468.06	468	6 - 5,5 mm	52,2	68	40
100468.07	468	7 - 6,5 mm	52,2	68	40
100468.08	468	8 - 7,5 mm	52,2	68	40
100468.09	468	9 - 8,5 mm	52,2	68	40
100468.10	468	10 - 9,5 mm	52,2	68	40
100468.11	468	11 - 10,5 mm	52,2	68	40
100468.12	468	12 - 11,5 mm	52,2	68	40
100468.13	468	13 - 12,5 mm	52,2	68	40
100468.14	468	14 - 13,5 mm	52,2	68	40
100468.15	468	15 - 14,5 mm	52,2	68	40
100468.16	468	16 - 15,5 mm	52,2	68	40
100468.17	468	17 - 16,5 mm	52,2	68	40
100468.18	468	18 - 17,5 mm	52,2	68	40
100468.19	468	19 - 18,5 mm	52,2	68	40
100468.20	468	20 - 19,5 mm	52,2	68	40
100468.21	468	21 - 20,5 mm	52,2	68	40
100468.22	468	22 - 21,5 mm	52,2	68	40

Sipariş Kodu Order Number	Pens Collet	Kapasite Capacity (d)	D	L	€
100468.23	468	23 - 22,5 mm	52,2	68	40
100468.24	468	24 - 23,5 mm	52,2	68	40
100468.25	468	25 - 24,5 mm	52,2	68	40
100468.26	468	26 - 25,5 mm	52,2	68	40
100468.27	468	27 - 26,5 mm	52,2	68	40
100468.28	468	28 - 27,5 mm	52,2	68	40
100468.29	468	29 - 28,5 mm	52,2	68	40
100468.30	468	30 - 29,5 mm	52,2	68	40
100468.31	468	31 - 30,5 mm	52,2	68	40
100468.32	468	32 - 31,5 mm	52,2	68	40
100468.33	468	33 - 32,5 mm	52,2	68	40
100468.34	468	34 - 33,5 mm	52,2	68	40
100468.35	468	35 - 34,5 mm	52,2	68	40
100468.36	468	36 - 35,5 mm	52,2	68	40
100468.37	468	37 - 36,5 mm	52,2	68	40
100468.38	468	38 - 37,5 mm	52,2	68	40
100468.39	468	39 - 38,5 mm	52,2	68	40
100468.40	468	40 - 39,5 mm	52,2	68	40

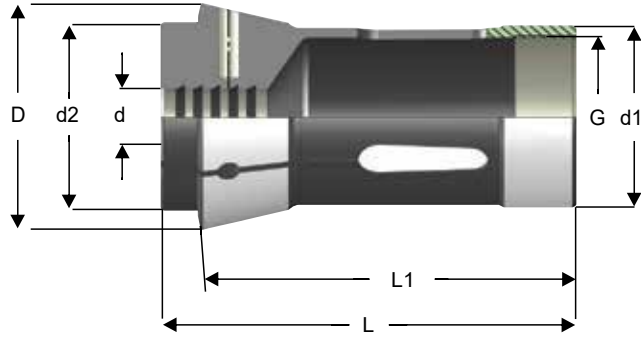

Sipariş Kodu Order Number	Pens Collet	Profil	Kapasite Capacity (d)	d1	d2	D	L1	L	G	€
110042.XX	173 D	○	5-42 mm	48	50	60	85	94	M43x1	59
111042.XX	173 D	⬡	6-37 mm	48	50	60	85	94	M43x1	92
110060.XX	185 D	○	6-60 mm	66	73	84	101	110	M61x1	118
111060.XX	185 D	⬡	8-52 mm	66	73	84	101	110	M61x1	156

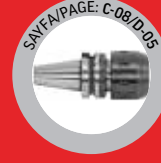
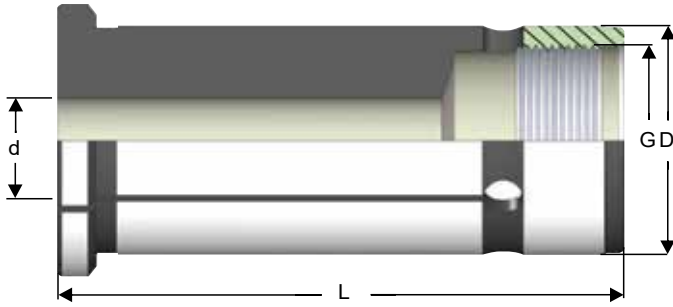

Sipariş Kodu Order Number	Ø	Kapasite Capacity (d)	D	L	G	€
150020.XX	20	3-16	20	60	M16x1	28
150025.XX	25	3-20	25	68	M21x1	30
150032.XX	32	3-25	32	70	M26x1	32

DIN 6388**BAŞLIKSIZ ANAHTARLI E TİPİ TAKIMLAR**
COLLET SET IN BOX E SERIES WITH WRENCH**DEĞERLİ®**
www.degerlimakina.com

Sipariş Kodu Order Number	Pens Collet	Adet Piece	Ölçüler Contents	€
000415	415	15	3-4-5-6-7-8-9-10-11-12-13-14-15-16 - 904042	237
000462	462	17	4-5-6-7-8-9-10-11-12-14-16-18-20-22-24-25 - 905862	340
000467	467	17	5-6-7-8-10-12-14-16-18-20-22-24-25-28-30-32 - 906875	490
000468	468	21	6-7-8-9-10-12-14-16-18-20-22-24-25-28-30-32-34-36-38-40 - 908090	850



Sipariş Kodu Order Number	Pens Collet	Adet Piece	Ölçüler Contents	€
000426	ER 16 / 426	8	3-4-5-6-7-8-9-10	120
000428	ER 20 / 428	11	3-4-5-6-7-8-9-10-11-12-13	170
000430-1	ER 25 / 430	14	3-4-5-6-7-8-9-10-11-12-13-14-15-16	235
000470-1	ER 32 / 470	18	3-4-5-6-7-8-9-10-11-12-13-14-15-16-17-18-19-20	295
000472-1	ER 40 / 472	23	4-5-6-7-8-9-10-11-12-13-14-15-16-17-18-19-20-21-22-23-24-25-26	482

DIN 6499**BAŞLIKSIZ ANAHTARLI ER SERİSİ TAKIMLAR**
COLLET SET IN BOX ER SERIES WITH WRENCH**DEĞERLİ**
www.degerlimakina.com

Sipariş Kodu Order Number	Pens Collet	Adet Piece	Ölçüler Contents	€
000430	ER 25 / 430	13	3-4-5-6-7-8-9-10-11-12-14-16 - 9042430	250
000470	ER 32 / 470	15	3-4-5-6-7-8-9-10-11-12-14-16-18-20 - 9050470	255
000472	ER 40 / 472	17	4-5-6-7-8-9-10-11-12-14-16-18-20-22-24-26 - 9063472	370



Sipariş Kodu
Order Number

Ürün Adı
Product Name

€

510470.MRZ

SK 30 / ER 32 - 470 / CNC CARPENTER COLLET CHUCK (A - 50)

62

510470.MRZS

SK 30 / ER 32 - 470 SOMUNLU / CNC CARPENTER COLLET CHUCK

80

23065

SK 30 CNC MRZ PULLSTUD 6,5 RADIUS

14



Sipariş Kodu Order Number	Ürün Adı Product Name	€
HSK.01	HSK - F 63 / 462 (A - 78) / COLLET CHUCK	100
HSK.02	HSK - F 63 / ER-32 470 (A - 70) / COLLET CHUCK	100
HSK.03	HSK - F 63 / ER-40 472 (A - 78) / COLLET CHUCK	100

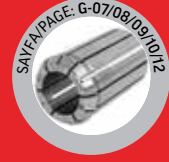

Sipariş Kodu Order Number	Cinsi Size	d	D	€
904042	415	40	42	12
904550	6-20	45	50	14
905862	462	58	62	13
906875	467 / 6-32	68	75	14
908090	468	80	90	17



Sipariş Kodu Order Number	Cinsi Size	Kapasite Capacity (d)	€
9022426	426 (ER 16) MİNİ	22	23
9028428	428 (ER 20) MİNİ	28	24
9032426	426 (ER 16)	32	16
9035428	428 (ER 20)	35	18
9042430	430 (ER 25)	42	18
9050470	470 (ER 32)	50	22
9063472	472 (ER 40)	63	27

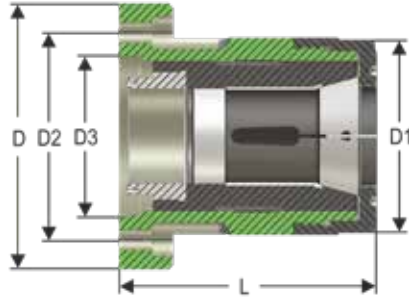

Sipariş Kodu Order Number	Max Devir Max Rpm	D	L	D1	D3	D2	Pens Kodu Collet Nr.	€
93040	5000	135	132	100	6"	104,8	173 D	488
93140	5000	165	134	118	8"	133,4	173 D	530
93060	4500	165	151	122	8"	133,4	185 D	635
93160	4000	208	154	138	10"	171,4	185 D	1016



HPA MAŞONLAR / HPA INNER BUSH WITH BUSHES NUT

Sipariş Kodu Order Number	M	€
93040-1	M66x1,5	33
93140-1	M80x1,5	33
93060-1	M80x1,5	33
93160-1	M98x1,5	33

HPA KAPAK ANAHTARI / WRENCH OF HPA CLAMPING NUT

Sipariş Kodu Order Number	D	€
93040 / 93140 -2	66	40
93060 / 93160 -2	87	40

HPA MAŞON ANAHTARI / HPA ASSEMBLING WRECH

Sipariş Kodu Order Number	D	€
93140-3	48	40
93060-3	64	40

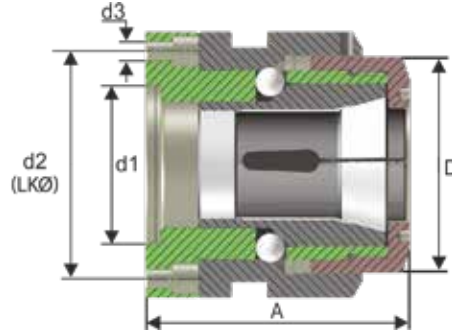

Sipariş Kodu Order Number	Pens Collet	Max Devir Max Rpm	D	d1	LkØ	d2	A	d3	€
92040	173 D	2000	96	70	101	6 x 8,5	130	8,5	900

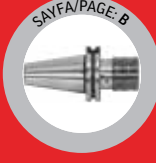

Sipariş Kodu Order Number	Ø	D	d	L	Kare Square	€
8 19 28.M2	2,8	32	19	25	2,1	42
8 19 28.M2,5	2,8	32	19	25	2,1	42
8 19 35.M3	3,5	32	19	25	2,7	42
8 19 40.M3,5	4	32	19	25	3,0	42
8 19 45.M4	4,5	32	19	25	3,4	42
8 19 60.M5	6	32	19	25	4,9	42
8 19 60.M6	6	32	19	25	4,9	42
8 19 80.M8	8	32	19	25	6,2	42
8 19 70.M10	7	32	19	25	5,5	42
8 19 10.M10	10	32	19	25	8,0	42
8 19 90.M12	9	32	19	25	7,0	42
8 19 11.M14	11	32	19	25	9,0	42

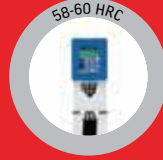
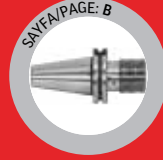

Sipariş Kodu Order Number	Ø	D	d	L	Kare Square	€
8 31 60.M5	6	50	31	31	4,9	48
8 31 60.M6	6	50	31	31	4,9	48
8 31 80.M8	8	50	31	31	6,2	48
8 31 70.M10	7	50	31	31	5,5	48
8 31 10.M10	10	50	31	31	8,0	48
8 31 90.M12	9	50	31	31	7,0	48
8 31 11.M14	11	50	31	31	9,0	48
8 31 12.M16	12	50	31	31	9,0	48
8 31 14.M18	14	50	31	31	11,0	48
8 31 16.M20	16	50	31	31	12,0	48
8 31 18.M22	18	50	31	31	14,5	48
8 31 18.M24	18	50	31	31	14,5	48

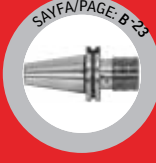

Sipariş Kodu Order Number	Ø	D	d	L	Kare Square	€
8 48 11.M14	11	72	48	41	9,0	108
8 48 12.M16	12	72	48	41	9,0	108
8 48 14.M18	14	72	48	41	11,0	108
8 48 16.M20	16	72	48	41	12,0	108
8 48 18.M22	18	72	48	41	14,5	108
8 48 18.M24	18	72	48	41	14,5	108
8 48 20.M27	20	72	48	41	16,0	108
8 48 22.M30	22	72	48	41	18,0	108
8 48 25.M33	25	72	48	41	20,0	108
8 48 28.M36	28	72	48	41	22,0	108

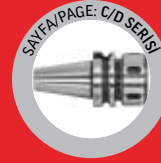
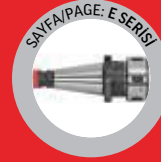
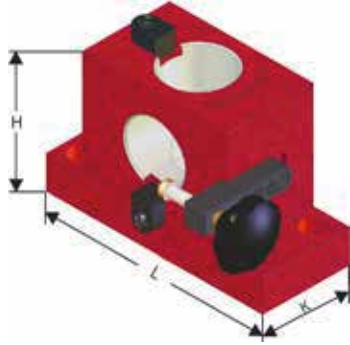
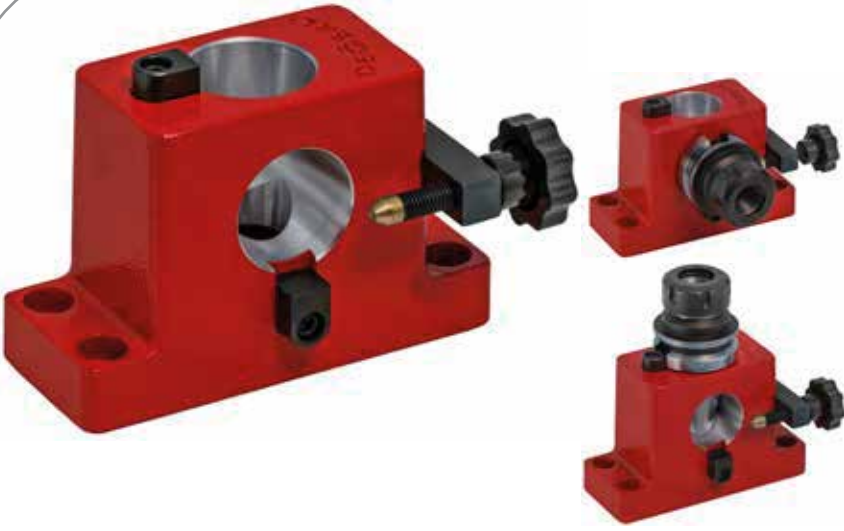

Sipariş Kodu
Order Number

Cinsi
Size

H

L

K

€

65040

ISO 30 / BT 30 / SK 30

105

160

62

85

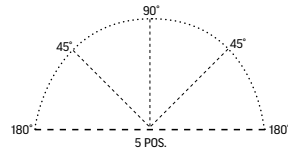

Sipariş Kodu Order Number	Cinsi Size	H	L	K	€
55030	ISO 30 / BT 30 / SK 30	121	100	48	116
55040	ISO 40 / BT 40 / SK 40	136	130	64	116
55050	ISO 50 / BT 50 / SK 50	170	170	72	137
55063	HSK - A 63	136	130	64	161
55030.MRZ	SK 30 MRZ / WOOD CNC	121	100	48	116
55063.MRZ	HSK - F 63 MRZ / WOOD CNC	136	130	64	161

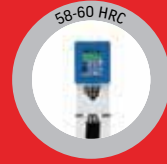
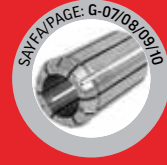
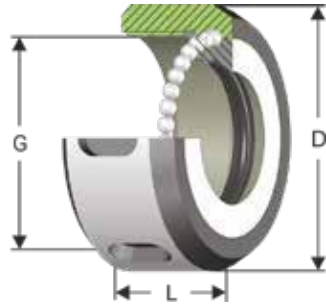

Sipariş Kodu Order Number	Cinsi Size	Kapasite Capacity (d)	D	G	L	€
40415	415	2-16 mm	43	M33 x 1,5	24	22
40462	462	2-25 mm	60	M48 x 2	30	26
40467	467	3-32 mm	72	M60 x 2,5	33,5	31
40468	468	4-40 mm	85	M68 x 2,5	37	48

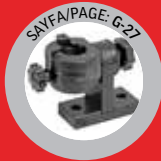

TYPE 1

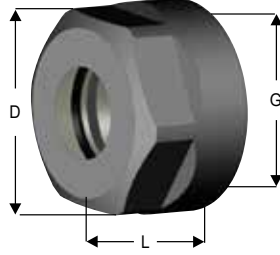

TYPE 2

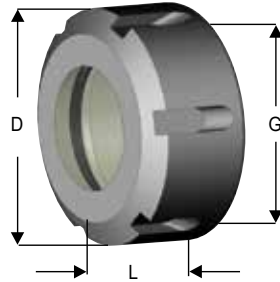

TYPE 3

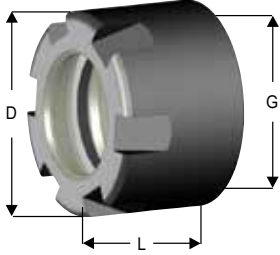

Sipariş Kodu Order Number	Cinsi Size	Kapasite Capacity (d)	D	G	L	SW	TYPE	€
40426	ER 16 - 426	2-10 mm	28	M22 x 1,5	17,5	25	1	15
41426	ER 16 - 426 MİNİ	2-10 mm	22	M19 x 1	18	-	3	20
42426	ER 16 - 426	2-10 mm	32	M22 x 1,5	17,5	-	2	15
40428	ER 20 - 428	2-13 mm	34	M25 x 1,5	19	30	1	20
41428	ER 20 - 428 MİNİ	2-13 mm	28	M24 x 1	19	-	3	22
42428	ER 20 - 428	2-13 mm	35	M25 x 1,5	19	-	2	20
40430	ER 25 - 430	2-16 mm	42	M32 x 1,5	20	-	2	17
40470	ER 32 - 470	2-20 mm	50	M40 x 1,5	22,5	-	2	18
40472	ER 40 - 472	2-26 mm	63	M50 x 1,5	25,5	-	2	21

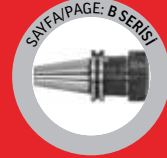
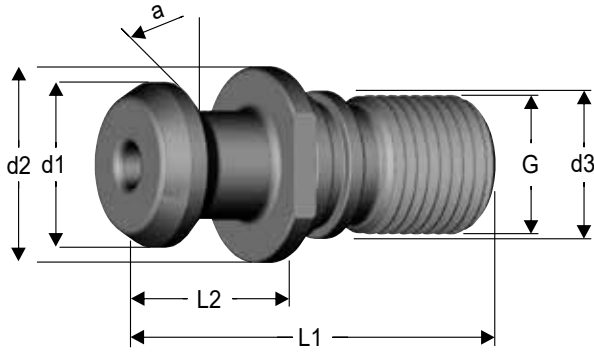

Sipariş Kodu Order Number	Ürün Adı Product Name	d1	d2	d3	L1	L2	G	a	€
21445	CAT 40 MAZAK PULLSTUD	18,80	22	17	41,25	16,10	M16	45°	8
21445.1	BT 40 MAZAK PULLSTUD	18,80	22,5	17	44,10	19,10	M16	45°	9
21545	ISO 7388 / B 50 PULLSTUD	28,95	37	25	65,40	25,40	M24	45°	9
22445	ISO 7388 / B 40 PULLSTUD	18,95	22,5	17	44,50	16,40	M16	45°	8
22545	CAT 50 MAZAK PULLSTUD	29,10	37	25	65,50	25,55	M24	45°	10
24445	HAAS PULLSTUD	15	23	17	57	32	M16	45°	10
24445.1	HAAS WITH THROUGH HOLE AND O-RING Ø 3,5 mm	15	23	17	57	32	M16	45°	14

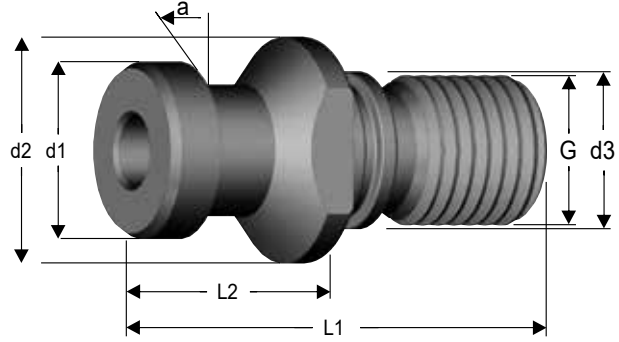

Sipariş Kodu Order Number	Ürün Adı Product Name	d1	d2	d3	L1	L2	G	a	€
23015	DIN 69872 SK 30 PULLSTUD	13	17	13	44	24	M12	15°	9
24015	DIN 69872 SK 40 PULLSTUD	19	23	17	54	26	M16	15°	8
25015	DIN 69872 SK 50 PULLSTUD	28	36	25	74	34	M24	15°	9
24115	DIN 69872 SK 40 İ.S.V. PULLSTUD	19	23	17	54	26	M16	15°	9
25115	DIN 69872 SK 50 İ.S.V. PULLSTUD	28	36	25	74	34	M24	15°	10
24215	MAKİNO Ø 5 mm WITH THROUGH HOLE	19	23	17	54	29	M16	15°	10
24315	OKUMA Ø 7 mm WITH THROUGH HOLE AND O-RING	19	23	17	54	29	M16	15°	14
24415	OKUMA & MAKİNO Ø 7 mm WITH THROUGH HOLE	19	23	17	54	29	M16	15°	10

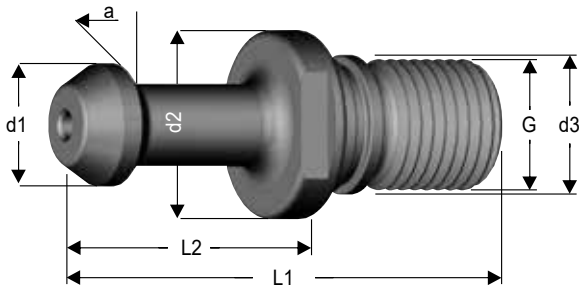

Sipariş Kodu Order Number	Ürün Adı Product Name	d1	d2	d3	L1	L2	G	a	€
23045	MAS 403 BT - BBT 30 PULLSTUD	11	16,5	12,5	43	23	M12	45°	8
24045	MAS 403 BT - BBT 40 PULLSTUD	15	23	17	60	35	M16	45°	8
25045	MAS 403 BT - BBT 50 PULLSTUD	23	38	25	85	45	M24	45°	9
23060	MAS 403 BT - BBT 30 PULLSTUD	11	16,5	12,5	43	23	M12	60°	8
24060	MAS 403 BT - BBT 40 PULLSTUD	15	23	17	60	35	M16	60°	8
25060	MAS 403 BT - BBT 50 PULLSTUD	23	38	25	85	45	M24	60°	9
23090	MAS 403 BT - BBT 30 PULLSTUD	11	16,5	12,5	43	23	M12	90°	8
24090	MAS 403 BT - BBT 40 PULLSTUD	15	23	17	60	35	M16	90°	8
25090	MAS 403 BT - BBT 50 PULLSTUD	23	38	25	85	45	M24	90°	9

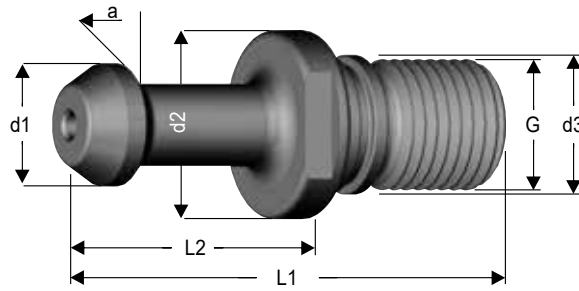

Sipariş Kodu Order Number	Ürün Adı Product Name	d1	d2	d3	L1	L2	G	a	€
23145	MAS 403 BT - BBT 30 İ.S.V. PULLSTUD	11	16,5	12,5	43	23	M12	45°	9
24145	MAS 403 BT - BBT 40 İ.S.V. PULLSTUD	15	23	17	60	35	M16	45°	9
25145	MAS 403 BT - BBT 50 İ.S.V. PULLSTUD	23	38	25	85	45	M24	45°	12
24160	MAS 403 BT - BBT 40 İ.S.V. PULLSTUD	15	23	17	60	35	M16	60°	9
25160	MAS 403 BT - BBT 50 İ.S.V. PULLSTUD	23	38	25	85	45	M24	60°	12
24190	MAS 403 BT - BBT 40 İ.S.V. PULLSTUD	15	23	17	60	35	M16	90°	9
25190	MAS 403 BT - BBT 50 İ.S.V. PULLSTUD	23	38	25	85	45	M24	90°	12

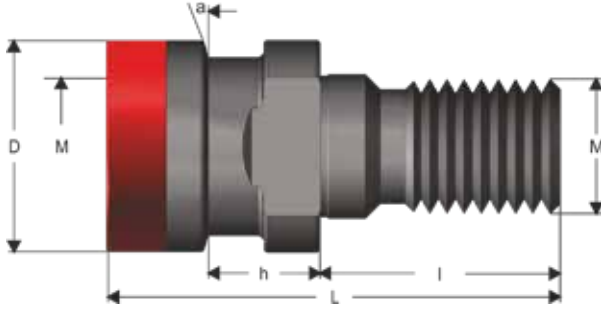

Sipariş Kodu Order Number	Ürün Adı Product Name	D	M	L	I	h	a	€
26016	40 İÇTEN ÇEKTİRMELİ PULLSTUD	25	M16	53	28	13,7	15°	10
26024	50 İÇTEN ÇEKTİRMELİ PULLSTUD	39,2	M24	65	40	13	15°	12

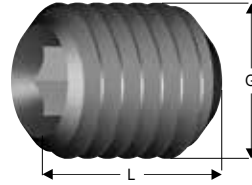
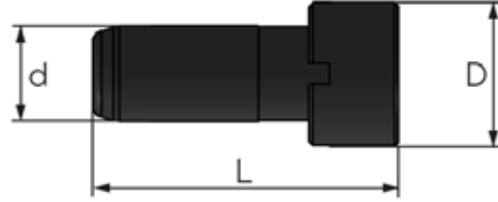
Sipariş Kodu
Order Number

HSK

d

D

L

€

HSK - A 63

A 63

12

M18 x 1

34.5

10

Sipariş Kodu
Order NumberÜrün Adı
Product Name

G

L

€

9006

WELDON 6

M6

10

5

9008

WELDON 8

M8

10

5

9010

WELDON 10

M10

12

5

9012

WELDON 12

M12

16

5

9016

WELDON 16

M14

16

5

9020

WELDON 20

M16

16

5

9025

WELDON 25

M18 x 2

20

8

9032

WELDON 32 - 40

M20 x 2

20

8

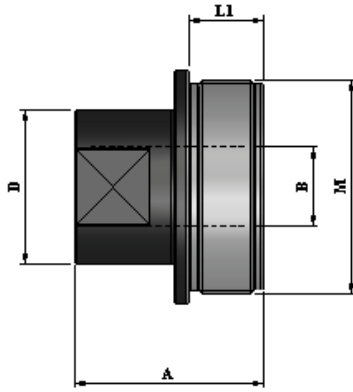

Sipariş Kodu Order Number	Ürün Adı Product Name	M	B	A	D	L1	€
110042.D	173 D	M43x1	M16	38	31	15	50
110060.D	185 D	M61x1	M16	38	31	15	60



Sipariş Kodu Order Number	ATB	€
63016	16	11
63022	22	11
63027	27	11
63032	32	11
63040	40	11

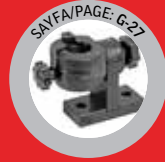
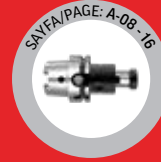
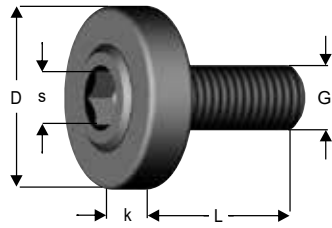

Sipariş Kodu Order Number	ATB / KTB	G	D	k	L	s	€
60816	16	M8	20	6	16	6	6
61022	22	M10	28	7	18	8	7
61227	27	M12	35	8	22	10	7
61632	32	M16	42	9	26	14	9
62040	40	M20	52	10	30	17	12



SAYFA/PAGE: C-09



SAYFA/PAGE: C-10



SAYFA/PAGE: C-11



SAYFA/PAGE: B-09/10



SAYFA/PAGE: E-11



SAYFA/PAGE: E-05/06



SAYFA/PAGE: A-08/09/10/11



SAYFA/PAGE: G-27



SAYFA/PAGE: G-26



58-60 HRC

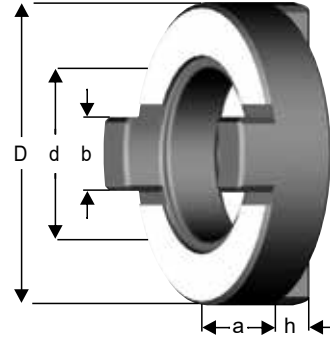

Sipariş Kodu Order Number	KTB	d	a	D	b	h	€
64016	16	16	10	32	8	5	8
64022	22	22	12	40	10	5,6	10
64027	27	27	12	48	12	6,3	10
64032	32	32	14	58	14	7	12
64040	40	40	14	70	16	8	20

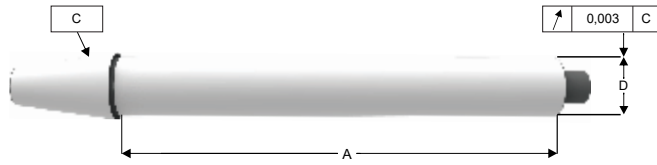

Sipariş Kodu Order Number	BT - SK	A	D	€
0030-1	30	200	32	325
0040-1	40	300	40	300
0050-1	50	300	50	500

**The prices are clear and it is no discount.
The profit rate is determined by yourself.
Fiyatlar net olup iskonto uygulanmayacaktır.
Satıcı kârını kendisi belirleyecektir.**



Sipariş Kodu Order Number	BT - SK	€
0030	30	1600
0040	40	1150
0050	50	1250

**The prices are clear and it is no discount.
The profit rate is determined by yourself.**

**Fiyatlar net olup iskonto uygulanmayacaktır.
Satıcı kârını kendisi belirleyecektir.**

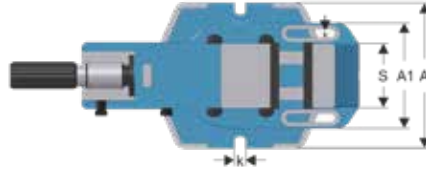
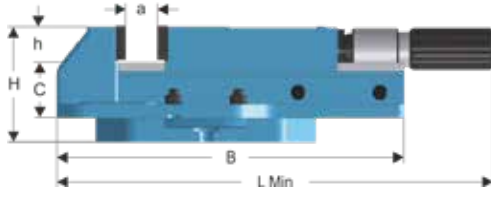
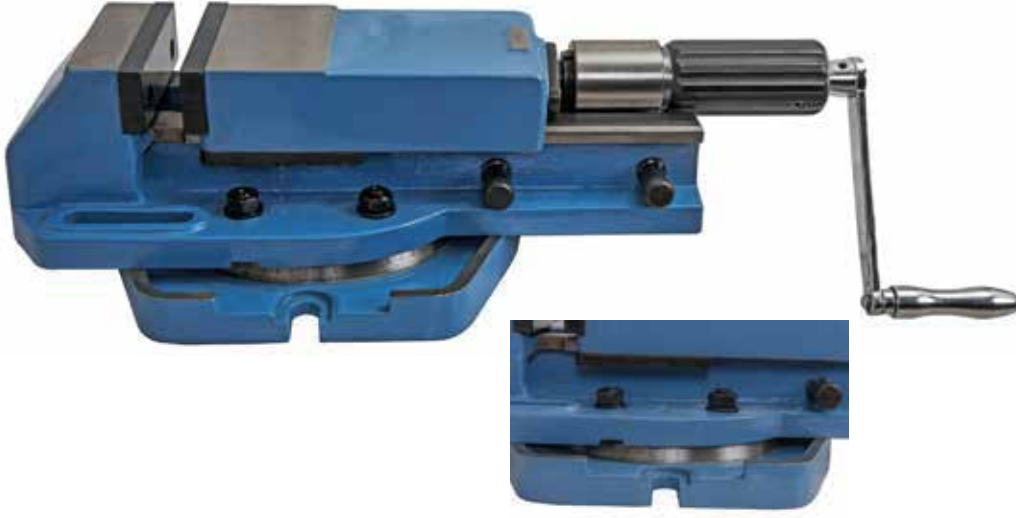

Sipariş Kodu Order Number	A	A1	S	k	a	h	h	h	h	h	Sıkma Gücü Press Power	Sıkma Gücü Press Power	€
10100	270	200	122	16	0-210	45	45	45	45	45	3,5 - 4 Ton	3,5 - 4 Ton	900



Sipariş Kodu
Order Number

Cinsi
Size

€

T-2000

ER16 - ER20

13

T-2004

ER25 - ER32 - 415

22

T-2007

ER32 - ER40 - 462 - 467 - RPT 6-32

24

T-2008

ER32 - ER40 - 462 - 467

27

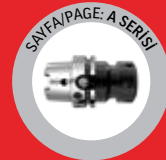
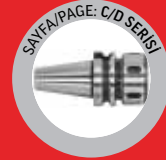
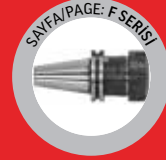
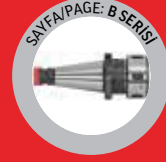
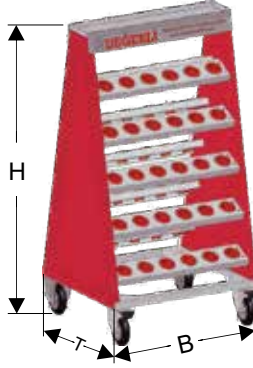
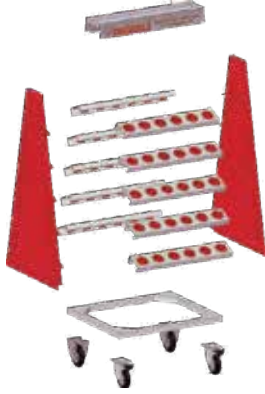

Sipariş Kodu Order Number	ISO / BT / SK / HSK	Kapasite Capacity (d)	H	T	B	€
8030	30	70	1260	600	700	450
8040	40	60	1260	600	700	450
8050	50	50	1260	600	700	450
8063	63	60	1260	600	700	450

2023

FİYAT LİSTESİ
PRICE LIST



DEĞERLİ®

www.degerlimakina.com

